

International Energy Agency

# **Annex 75 | Cost-effective Building Renovation at District Level Combining Energy Efficiency & Renewables**

---

**Energy in Buildings and Communities  
Programme**

May 2020

# **Subtask A: Technology overview**

International Energy Agency

# Annex 75 | Cost-effective Building Renovation at District Level Combining Energy Efficiency & Renewables

## Subtask A: Technology overview

---

### Energy in Buildings and Communities Programme

May 2020

#### Main authors

Ove C. Mørck (Subtask A leader), Kuben Management, Denmark

Jørgen Rose, SBi, Aalborg University, Denmark

Kirsten Engelund Thomsen, SBi, Aalborg University, Denmark

Tomáš Matuška, Czech Technical University in Prague, Czech Republic

Sergio Vega Sánchez, Universidad Politécnica de Madrid, Spain

#### Contributors

David Venus, AEE INTEC; Philip Horn, Austrian Institute of Technology, Austria

Fabio Peron and Piercarlo Romagnoni, University of Venice, Italy

Erwin Mlecnik, TU Delft, Netherlands

Harald Walnum, SINTEF, Norway

Manuela Almeida and Ricardo Barbosa, University of Minho, Portugal

Juan Maria Hidalgo, Laboratory of Quality Control of Buildings of the Basque Government;

Jon Terés Zubiaga, University of the Basque Country, Spain

Erik Johansson and Henrik Davidsson, Lund University, Sweden

Roman Bolliger and Silvia Domingo-Irigoyen, INDP, Switzerland

Uta Lynar, Beratungs- und Service-Gesellschaft Umwelt mbH; Hauke Meyer, German Association of Housing Urban Design and Spatial Planning, Germany

# Preface

## **The International Energy Agency**

The International Energy Agency (IEA) was established in 1974 within the framework of the Organisation for Economic Co-operation and Development (OECD) to implement an international energy programme. A basic aim of the IEA is to foster international co-operation among the 29 IEA participating countries and to increase energy security through energy research, development and demonstration in the fields of technologies for energy efficiency and renewable energy sources.

## **The IEA Energy in Buildings and Communities Programme**

The IEA co-ordinates international energy research and development (R&D) activities through a comprehensive portfolio of Technology Collaboration Programmes. The mission of the Energy in Buildings and Communities (EBC) Programme is to develop and facilitate the integration of technologies and processes for energy efficiency and conservation into healthy, low emission, and sustainable buildings and communities, through innovation and research. (Until March 2013, the IEA-EBC Programme was known as the Energy in Buildings and Community Systems Programme, ECBCS.)

The research and development strategies of the IEA-EBC Programme are derived from research drivers, national programmes within IEA countries, and the IEA Future Buildings Forum Think Tank Workshops. The research and development (R&D) strategies of IEA-EBC aim to exploit technological opportunities to save energy in the buildings sector and to remove technical obstacles to market penetration of new energy efficient technologies. The R&D strategies apply to residential, commercial, office buildings and community systems, and will impact the building industry in five focus areas for R&D activities:

- Integrated planning and building design
- Building energy systems
- Building envelope
- Community scale methods
- Real building energy use

## **The Executive Committee**

Overall control of the IEA-EBC Programme is maintained by an Executive Committee, which not only monitors existing projects but also identifies new strategic areas in which collaborative efforts may be beneficial. As the Programme is based on a contract with the IEA, the projects are legally established as Annexes to the IEA-EBC Implementing Agreement. At the present time, the following projects have been initiated by the IEA-EBC Executive Committee, with completed projects identified by (\*):

- Annex 1: Load Energy Determination of Buildings (\*)
- Annex 2: Ekistics and Advanced Community Energy Systems (\*)
- Annex 3: Energy Conservation in Residential Buildings (\*)
- Annex 4: Glasgow Commercial Building Monitoring (\*)
- Annex 5: Air Infiltration and Ventilation Centre
- Annex 6: Energy Systems and Design of Communities (\*)
- Annex 7: Local Government Energy Planning (\*)
- Annex 8: Inhabitants Behaviour with Regard to Ventilation (\*)
- Annex 9: Minimum Ventilation Rates (\*)
- Annex 10: Building HVAC System Simulation (\*)
- Annex 11: Energy Auditing (\*)
- Annex 12: Windows and Fenestration (\*)
- Annex 13: Energy Management in Hospitals (\*)
- Annex 14: Condensation and Energy (\*)
- Annex 15: Energy Efficiency in Schools (\*)
- Annex 16: BEMS 1- User Interfaces and System Integration (\*)
- Annex 17: BEMS 2- Evaluation and Emulation Techniques (\*)
- Annex 18: Demand Controlled Ventilation Systems (\*)
- Annex 19: Low Slope Roof Systems (\*)
- Annex 20: Air Flow Patterns within Buildings (\*)
- Annex 21: Thermal Modelling (\*)
- Annex 22: Energy Efficient Communities (\*)
- Annex 23: Multi Zone Air Flow Modelling (COMIS) (\*)
- Annex 24: Heat, Air and Moisture Transfer in Envelopes (\*)
- Annex 25: Real time HVAC Simulation (\*)
- Annex 26: Energy Efficient Ventilation of Large Enclosures (\*)

- Annex 27: Evaluation and Demonstration of Domestic Ventilation Systems (\*)
- Annex 28: Low Energy Cooling Systems (\*)
- Annex 29: Daylight in Buildings (\*)
- Annex 30: Bringing Simulation to Application (\*)
- Annex 31: Energy-Related Environmental Impact of Buildings (\*)
- Annex 32: Integral Building Envelope Performance Assessment (\*)
- Annex 33: Advanced Local Energy Planning (\*)
- Annex 34: Computer-Aided Evaluation of HVAC System Performance (\*)
- Annex 35: Design of Energy Efficient Hybrid Ventilation (HYBVENT) (\*)
- Annex 36: Retrofitting of Educational Buildings (\*)
- Annex 37: Low Exergy Systems for Heating and Cooling of Buildings (LowEx) (\*)
- Annex 38: Solar Sustainable Housing (\*)
- Annex 39: High Performance Insulation Systems (\*)
- Annex 40: Building Commissioning to Improve Energy Performance (\*)
- Annex 41: Whole Building Heat, Air and Moisture Response (MOIST-ENG) (\*)
- Annex 42: The Simulation of Building-Integrated Fuel Cell and Other Cogeneration Systems (FC+COGEN-SIM) (\*)
- Annex 43: Testing and Validation of Building Energy Simulation Tools (\*)
- Annex 44: Integrating Environmentally Responsive Elements in Buildings (\*)
- Annex 45: Energy Efficient Electric Lighting for Buildings (\*)
- Annex 46: Holistic Assessment Tool-kit on Energy Efficient Retrofit Measures for Government Buildings (EnERGo) (\*)
- Annex 47: Cost-Effective Commissioning for Existing and Low Energy Buildings (\*)
- Annex 48: Heat Pumping and Reversible Air Conditioning (\*)
- Annex 49: Low Exergy Systems for High Performance Buildings and Communities (\*)
- Annex 50: Prefabricated Systems for Low Energy Renovation of Residential Buildings (\*)
- Annex 51: Energy Efficient Communities (\*)
- Annex 52: Towards Net Zero Energy Solar Buildings (\*)
- Annex 53: Total Energy Use in Buildings: Analysis & Evaluation Methods (\*)
- Annex 54: Integration of Micro-Generation & Related Energy Technologies in Buildings (\*)
- Annex 55: Reliability of Energy Efficient Building Retrofitting - Probability Assessment of Performance & Cost (RAP-RETRO) (\*)
- Annex 56: Cost Effective Energy & CO2 Emissions Optimization in Building Renovation
- Annex 57: Evaluation of Embodied Energy & CO2 Equivalent Emissions for Building Construction
- Annex 58: Reliable Building Energy Performance Characterisation Based on Full Scale Dynamic Measurements (\*)
- Annex 59: High Temperature Cooling & Low Temperature Heating in Buildings (\*)
- Annex 60: New Generation Computational Tools for Building & Community Energy Systems (\*)
- Annex 61: Business and Technical Concepts for Deep Energy Retrofit of Public Buildings (\*)
- Annex 62: Ventilative Cooling (\*)
- Annex 63: Implementation of Energy Strategies in Communities (\*)
- Annex 64: LowEx Communities - Optimised Performance of Energy Supply Systems with Exergy Principles (\*)
- Annex 65: Long-Term Performance of Super-Insulating Materials in Building Components and Systems (\*)
- Annex 66: Definition and Simulation of Occupant Behavior in Buildings (\*)
- Annex 67: Energy Flexible Buildings
- Annex 68: Indoor Air Quality Design and Control in Low Energy Residential Buildings
- Annex 69: Strategy and Practice of Adaptive Thermal Comfort in Low Energy Buildings
- Annex 70: Energy Epidemiology: Analysis of Real Building Energy Use at Scale
- Annex 71: Building Energy Performance Assessment Based on In-situ Measurements
- Annex 72: Assessing Life Cycle Related Environmental Impacts Caused by Buildings
- Annex 73: Towards Net Zero Energy Public Resilient Communities
- Annex 74: Competition and Living Lab Platform
- Annex 75: Cost-effective Building Renovation at District Level Combining Energy Efficiency & Renewables
- Annex 76: EBC Annex 76 / SHC Task 59 Deep Renovation of Historic Buildings Towards Lowest Possible Energy Demand and CO2 Emissions
- Annex 77: EBC Annex 77 / SHC Task 61 Integrated Solutions for Daylight and Electric Lighting
- Annex 78: Supplementing Ventilation with Gas-phase Air Cleaning, Implementation and Energy Implications
- Annex 79: Occupant-Centric Building Design and Operation
- Annex 80: Resilient Cooling
- Annex 81: Data-Driven Smart Buildings
- Working Group - Energy Efficiency in Educational Buildings (\*)
- Working Group - Indicators of Energy Efficiency in Cold Climate Buildings (\*)
- Working Group - Annex 36 Extension: The Energy Concept Adviser (\*)
- Working Group - Survey on HVAC Energy Calculation Methodologies for Non-residential Buildings



# Table of contents

1. Executive summary	7
2. Introduction	9
3. Technology overview	12
3.1. Demand reductions / energy saving technologies	13
3.1.1. Windows	13
3.1.2. Insulation + Façades	17
3.1.3. Decentralised ventilation system with heat recovery	26
3.1.4. Shading systems	30
3.1.5. Building automation control systems (BACS)/Energy monitoring systems (EMS)	35
3.2. Energy distribution and supply systems	39
3.2.1. Low-temperature thermal grids	39
3.2.2. Cogeneration	43
3.2.3. Cooling	52
3.2.4. Ground, water and air source heat pumps connected to district heating	57
3.2.5. Solar Thermal	66
3.2.6. Photovoltaic solar panels (PV)	70
3.2.7. PVT	73
3.3. Energy storage systems	78
3.3.1. Thermal Energy Storage (TES)	78
3.3.2. Electrical storage	82
4. Techno-economic characterization	85
4.1. Survey	85
4.2. PV systems	86
4.3. Solar thermal	89
4.4. Heat pumps	91
4.5. Conclusion	94
4.6. References	95
5. Interdependencies, obstacles, and success factors	96
5.1. Global approach to interdependencies, obstacles, and success factors	96
5.2. Technical interdependencies, obstacles, and success factors	97
5.3. Interdependencies Factsheet definition	99

5.3.1. Interdependencies Factsheet template _____	99
5.3.2. Content definition _____	102
5.4. Datasheets on interdependencies, obstacles and success factors _____	104
5.5. References _____	104
6. Potentials and future developments _____	105
6.1. Windows _____	105
6.1.1. Smart-windows _____	105
6.1.2. Window spacer-integrated PV _____	107
6.2. Prefabricated facades _____	108
6.3. Photovoltaics (PV) _____	111
6.4. Building automation systems/energy management systems _____	115
6.5. Low temperature thermal grid (LTTG) _____	115
6.6. Ground Source Heat pumps _____	116
6.7. Solar thermal _____	119
6.8. Thermal storage _____	121
6.8.1. Phase change materials [PCM] _____	122
6.8.2. Seasonal thermal storage _____	123
6.9. Electrical storage _____	125
6.9.1. Lithium-ion batteries (LIB) for grid-scale storage _____	126
6.9.2. Vanadium redox flow batteries _____	126
6.9.3. Vehicle-to-grid (V2G) _____	127
6.10. Ventilation _____	128
6.11. Fuel cells/hydrogen production _____	129
6.12. Future perspectives on electricity network _____	132
6.13. Demand side management (peak shaving) _____	134
7. References _____	138
Appendix I – Datasheets on interdependencies, obstacles and success factors _____	139

# 1. Executive summary

This report is the first of the deliverables from the IEA Annex 75 project. It documents the work of Subtask A – Technology Overview. As the title of the subtask indicates, the idea of this subtask was to create an overview of the available technologies for energy renovation and renewable energy supply at district level.

The work has been carried out in a number of steps. In the first step, candidate technologies were identified among the project participants and briefly documented in a standard (mini-) template.

The 25 technologies identified and described were compiled in a short report (“Technology overview – Subtask A Work Package A1”), which is available at the project website:

[http://annex75.iea-ebc.org/Data/publications/Annex%2075\\_WIP\\_Technology%20Overview.pdf](http://annex75.iea-ebc.org/Data/publications/Annex%2075_WIP_Technology%20Overview.pdf)

In the second step, based on their individual relevance in regards to the scope of the project, technologies were selected and combined into 14 main technologies. The technologies are documented in this report using a (maxi-) template providing also technical as well as financial and environmental information. The 14 technologies have been subdivided into three overarching categories:

- Demand reduction - energy saving technologies (5 technologies)
- Energy distribution and supply systems (7 technologies)
- Energy storage systems (2 technologies)

It should be noted that the list of technologies documented in no way is to be considered exhaustive. The idea has been to document the technologies with a potential for cost reductions when implemented for a series of buildings at the urban scale, as well as technologies with a clear potential to be implemented at an urban scale for energy supply and storage.

In a third step, data for the identified technologies on their technical performance and costs were identified, collected and documented. This was done via a survey to the countries participating in Annex 75. An excel sheet template was developed for each of the technologies and distributed amongst the participants. Data was received for eight of the participating countries. Data on measures for individual buildings are readily available. Data on renewable energy sources, PV and solar thermal applications, together with heat pumps, are covered quite well, while data on cooling units, PVT collectors (still quite new on the market) or biomass combined heat and power are covered to a lesser extent. The consistency of the data for PV systems, solar thermal and heat pumps were checked by comparing the received data from the different countries. Quite large absolute differences in costs were observed, but the trends showing reduced costs with size (economy of scale) were consistent between different national contexts.



The fourth step was an analysis of the interdependencies, obstacles factors and success factors for implementing individual technologies and furthermore identifying cost-effective combination of technologies and strategies. In order to fulfil the objective of intervening in buildings and districts in such a way that a renovated Net Zero Energy Districts is achieved, this work started from a holistic approach. This allowed to create a map of processes and a flow diagram of all the phases of the process, agents and stakeholders involved - the main key drivers that must support a successful renovation of Net Zero Energy Districts. In this report, however, the work presented is limited to the technical aspects of the reported technologies and documented in a fact sheet for each of the technologies covering the interdependencies, obstacles and success factors. None of the technologies and strategies analysed are applicable to different climatic conditions and uses, and it is the analysis of the interdependencies between combinations of technologies and strategies and the identification of what their efficiency depends on that allows their cost-effectiveness to be optimised.

In the fifth and final step, the technology options were put into context with available potentials, and an outlook is made on their future developments. Possible and foreseen future developments are described for individual technologies in order to foresee possibilities for further improvements to efficiencies, reductions of price or major breakthroughs in technologies. Again, the primary intention has been to describe technologies most relevant to the Annex 75 work.

Summing up, the work carried out in subtask A has established an overview of a technology base that can be utilised in the calculations that will be carried out in subtask B regarding generic districts and for case studies in subtask C.

## 2. Introduction

The aim of subtask A was to provide an overview on the available technology options for energy renovation of building envelopes and for switching heating and cooling systems as well as domestic hot water systems into renewable energy based systems in districts.

Starting from a characterization of measures in single buildings (information readily available as already investigated in depth by other studies), a focus was put on identifying options for carrying out such measures at district level. Concerning energy efficiency measures on building envelopes, such options refer in particular to the cost-effective renovation of groups of buildings with a similar structure.

In many cities/districts, there is a possible untapped potential for renewable energy use based on low-grade renewable energy from the ground, from hydrothermal resources such as rivers, lakes, groundwater, aquifers or the sewage system as well as on the use of solar energy. However, so far, only few cities have made use of these opportunities. In this context, various novel technologies are characterized here, such as cascading heat pumps or high temperature heat pumps that can upgrade heat from low temperatures to high supply temperatures, which are often necessary in existing buildings and particularly in existing district heating systems. Furthermore, technology options considered includes the use of new types of "cool" district heating systems, where the working fluid is distributed to buildings without any upgrading of the heat source (making use of decentralized heat pumps in buildings for upgrading the heat source to the temperature required in each building). In addition, technology options using solar energy at district level, in particular in combination with storage capacities, are investigated.

The technical and economic characteristics of the technology options are also determined. This includes in particular information on their efficiency, cost elements such as investment costs and operational costs taking into account economies of scale. The interdependencies, obstacles and success factors for combining the technology options are also described.

The technology options are put into context with available potentials, and an outlook is made on their future developments.

Objectives of Annex 75 will be reached through the undertaking of the following activities - coordinated in four subtasks A-D:

### **Subtask A: Technology Overview**

Providing an overview on various technology options, taking into account existing and emerging efficient technologies with potential to be successfully applied within that context, and how challenges specifically occurring in an urban context can be overcome.

Subtask A is organized in the following work packages (WP):

- WP A1: Identification of existing and emerging technology options (both envelope and systems and at both building and urban scale)
- WP A2: Characterization of technology options (cooperation with WP B1)
- WP A3: Interdependencies, obstacles, and success factors for combining energy efficiency measures with renewable integration
- WP A4: Potentials and future developments

### **Subtask B: Optimization Methodology and Strategy Development**

Developing a methodology which can be applied to urban districts in order to identify such cost-effective strategies, supporting decision makers in the evaluation of the efficiency, impacts, cost-effectiveness and acceptance of various strategies for renovating urban districts.

Subtask B is organized in four work packages (WP):

- WP B1: Methodological guidelines and framework conditions
- WP B2: Adaption or development of optimization tools
- WP B3: Cost optimization with respect to varying energy and GHG reduction targets for generic reference districts
- WP B4: Strategy development

### **Subtask C: Case Studies**

Illustrating the development of such strategies in selected case studies and gather related best-practice examples.

Subtask C is organized in four work packages (WP):

- WP C1: Success stories
- WP C2: Parametric assessment of selected case studies
- WP C3: Enabling factors and obstacles for replicating success stories and implementing case studies
- WP C4: Good practice guidance for transforming existing districts into low-energy and low-emission districts

### **Subtask D: Policy Instruments, Stakeholder Dialogue, and Dissemination**

Providing recommendations to policy makers and energy related companies about how they can influence the uptake of cost-effective combinations of energy efficiency measures and renewable energy measures in building renovation at district level, and to give guidance to building owners/investors about related cost-effective renovation strategies.

Subtask D is organized in four work packages (WP):

- WP D1: Policy instruments
- WP D2: Business models and models for stakeholder dialogue (including user acceptance)

- WP D3: Guidelines
- WP D4: Dissemination

The main outcome of subtask A is this technology overview report. The report consists of the following parts:

1. Overview on state-of-the-art technology (chapter 3)
2. Techno-economic characterization of technology options (chapter 4)
3. Identification of interdependencies, obstacles, and success factors for combining energy efficiency measures with renewable integration (chapter 5)
4. Outlook to potentials and future developments (chapter 6)

### 3. Technology overview

The goal of the work package A1 was to identify existing and emerging energy technology options that may be interesting to implement at an urban scale. The identified technologies can be subdivided in three main categories:

- Demand reduction / energy saving technologies
- Energy distribution and supply systems
- Energy storage systems

The first category comprise technologies to be implemented at the individual building level. The idea was not to describe all existing technologies, but to select those with a potential for cost reductions when implemented for a series of buildings at the urban scale.

The second category includes both technologies that can be implemented at the urban scale and at building scale. The solar technologies – solar heating, PV and PVT can be implemented at both scales.

Also, both the electrical and the heating energy storage technologies may be implemented at both scales.

Please note that some of the technologies dealt with in this report have been addressed in other IEA EBC Annexes or IEA SHC Tasks. More information can be found at IEA EBC (<https://www.iea-ebc.org/>) and IEA SHC (<https://www.iea-shc.org/>).

Please also note that references are listed after each subsection throughout the chapter.

## 3.1. Demand reductions / energy saving technologies

### 3.1.1. Windows

Windows	
<i>Description</i>	<p>The primary function of windows is to allow daylight into the building and allow for visual communication with the exterior. Operable windows allow natural ventilation that can reduce cooling needs.</p> <p>For southern European climates, the primary challenge is to allow the daylight to enter while at the same time reducing the solar irradiation to avoid compromising the indoor climate (high indoor temperatures). Heat loss is also a focus but usually 2-pane windows with low emissivity coating will be adequate to reduce the heat loss while solar shading reduces heat gains.</p> <p>For northern European climates, the primary challenge is reducing the heat loss through the windows and this is typically achieved by using windows with 3 layers of glass. New windows with 4 layers of glass have emerged but are not common.</p> <p>Solar shading can be either fixed (eaves, balconies, trees etc.) or dynamic (blinds, curtains, shutters etc.). Solar shading should preferably be installed on the exterior side of the window to avoid overheating.</p> <p>Quadruple glazed windows is a relatively novel development and is therefore the primary focus of this technology description. Adding an extra layer of glass to the triple glazed unit presented several challenges, i.e. the total weight of the windows would make them difficult to work with and would most often require machinery for installation, solar energy transmission, i.e. g-value, would be too low significantly reducing the solar heat gains and finally light transmission would also be challenged.</p> <p>These issues, along with other things, were addressed in the EU 7<sup>th</sup> Framework Programme project MEM4WIN [1], and the solution was to use very thin thermally treated glass for the two internal panes.</p> <p>The weight of the quadruple glazed windows is therefore approximately the same as for triple glazed windows while light transmission is approximately 75% and solar energy transmission above 50%. The U-value of the glazing is typically around 0.3 W/m<sup>2</sup>K and total window U-value of around 0.5 W/m<sup>2</sup>K depending on the frame.</p> <p>Thermal conductivity of the glazing depends also on the type of gas between the glass panes. Argon and krypton have a lower conductivity than air; however, the performance</p>

improvement is moderate: “when 90 percent argon gas fill is used in a low-e IGU (Insulating Glass Unit) instead of air, the window’s U-value can be improved by up to 16 percent. Similarly, krypton improves the U-value in a low-e IGU by up to 27 percent”. (<https://www.thespruce.com/>)

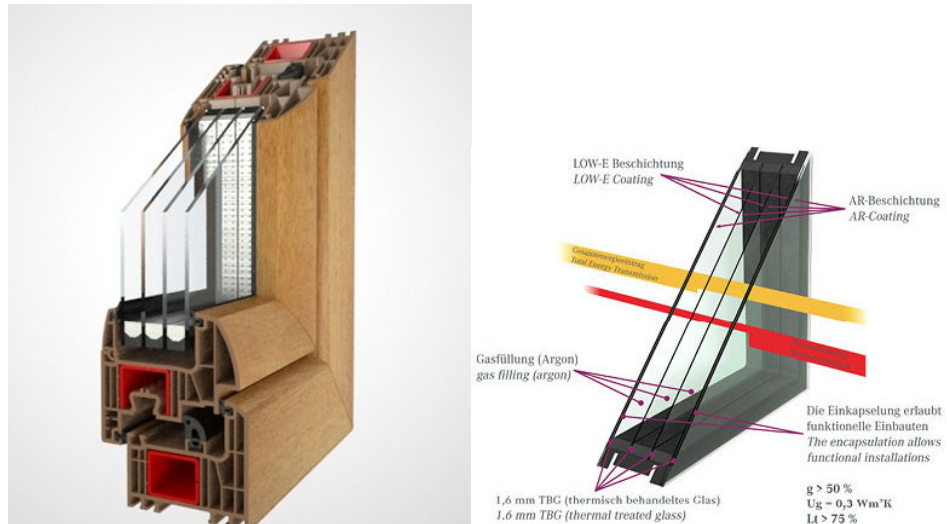

Figure 1. Examples of quadruple glazed windows (fenster-Jancic.at left and glaswelt.de right).

Different manufacturers exist and the glazing build-up varies. For regular windows the build-up of the glazing would typically be e.g. 64 mm wide (3/18/2/18/2/18/3) and for roof windows e.g. 54 mm wide (6/12/2/12/2/12/8).

<p><i>Main characteristics</i></p>	<p>The extra layer of glazing (compared to triple glazed windows) reduces the overall U-value and thereby the heat loss through the window significantly, e.g. from around 0.75 W/m<sup>2</sup>K to 0.50 W/m<sup>2</sup>K while maintaining a similar weight and similar characteristics regarding light and solar energy transmission.</p> <p>As with other windows, (triple or double glazed) the quadruple glazed window can be delivered with special solar shading capabilities etc. if needed.</p>
<p><i>Power range</i></p>	<p>N/A</p>
<p><i>Technology interdependencies</i></p>	<p>Replacing existing windows with quadruple glazed windows will significantly reduce the heat loss from a building, while maintaining similar characteristics regarding light and solar energy transmission. Thereby quadruple glazed windows will be most relevant to use in climates dominated by heating demands and less in climates dominated by cooling demands.</p> <p>New quadruple glazed windows could thereby be part of an overall reduction of the heating requirement that could result in a downscaling of the heating system or a transition to e.g.</p>

	<p>low temperature district heating. In addition, a correct installation of the windows will lead to a reduction in undesired air infiltrations and, therefore, an additional reduction in heating demand.</p> <p>When window replacement is carried out at the same time as facade insulation, this should be done first to ensure a correct insulation.</p>																								
<i>Advantages and disadvantages</i>	<p>Quadruple glazed windows will reduce the transmission heat loss through the glazed areas by approximately 25% (compared to triple glazed windows) while maintaining daylight levels and solar energy gains. The weight of the quadruple glazed windows has been kept comparable to that of triple glazed windows, so installation issues should also be comparable.</p> <p>The cost of quadruple glazed windows is approximately 20% higher compared to triple glazed windows and 25% higher compared to double-glazed windows [2].</p>																								
<i>Typical energy data and prices for window solutions</i>	<p>The following data is from [3] and includes glazing and frame:</p> <p>Table 1. Typical window data.</p> <table border="1"> <thead> <tr> <th>Window</th> <th>U [W/m<sup>2</sup>K]</th> <th>g [-]</th> <th>Price [€/m<sup>2</sup>]</th> </tr> </thead> <tbody> <tr> <td>2WS compact</td> <td>1.10</td> <td>0.63</td> <td>431</td> </tr> <tr> <td>3WS compact</td> <td>0.53</td> <td>0.53</td> <td>454</td> </tr> <tr> <td>3WS+ compact</td> <td>0.61</td> <td>0.60</td> <td>461</td> </tr> <tr> <td>4WS compact</td> <td>0.35</td> <td>0.42</td> <td>536</td> </tr> <tr> <td>4WS+ compact</td> <td>0.46</td> <td>0.59</td> <td>536</td> </tr> </tbody> </table>	Window	U [W/m <sup>2</sup> K]	g [-]	Price [€/m <sup>2</sup> ]	2WS compact	1.10	0.63	431	3WS compact	0.53	0.53	454	3WS+ compact	0.61	0.60	461	4WS compact	0.35	0.42	536	4WS+ compact	0.46	0.59	536
Window	U [W/m <sup>2</sup> K]	g [-]	Price [€/m <sup>2</sup> ]																						
2WS compact	1.10	0.63	431																						
3WS compact	0.53	0.53	454																						
3WS+ compact	0.61	0.60	461																						
4WS compact	0.35	0.42	536																						
4WS+ compact	0.46	0.59	536																						
<i>Energy performance</i>	<p>The light transmission is approximately 75% and solar energy transmission above 50%. The U-value of the glazing is typically around 0.3 – 0.5 W/m<sup>2</sup>K and total window U-value of around 0.5 – 0.7 W/m<sup>2</sup>K depending on the frame.</p>																								
<i>Financial data: investment, operation and maintenance</i>	<p>The quadruple glazed window will typically cost 599 €/m<sup>2</sup> installed window [4] and the expected lifetime is up to 30 years, as with other types of windows, dependent on the frame. Maintenance costs will depend on the frame (e.g. wood, wood/alu, PVC etc.)</p>																								
<i>Environmental issues</i>	<p>The production of glazing and aluminium framing are energy intensive processes contributing to adverse effects on climate. Effects can be reduced significantly by using recycled metals in production and ensuring a design in which glass panes and aluminium profiles can be reused or recycled at the end of the windows' service life. Another option is to use fiberglass for the framing material [9].</p>																								



<i>Development potential</i>	<p>Adding further layers of glazing is a possibility, however, there are limited possibilities in reducing the U-value further and it will be very difficult to go further without compromising weight, light transmission and solar energy transmission properties.</p> <p>Additional improvements could be linked to the development of highly-insulated frames or the integration of dynamically controllable glazing, including suspended particle devices (SPD), electrochromic, photochromic or thermochromic glass.</p>
<i>References</i>	<p>[1] mem4win.eu</p> <p>[2] <a href="https://passiv.de/downloads/05_report_smartwin_in_europe_final.pdf">https://passiv.de/downloads/05_report_smartwin_in_europe_final.pdf</a></p> <p>[3] <a href="http://www.passiv.de">www.passiv.de</a></p> <p>[4] <a href="http://www.passivhausfenster.com">www.passivhausfenster.com</a></p> <p>[5] <a href="http://www.glaswelt.de/Archiv/Newsletter-Archiv/article-688757-112170/4-fach-iso-amortisiert-sich-.html">www.glaswelt.de/Archiv/Newsletter-Archiv/article-688757-112170/4-fach-iso-amortisiert-sich-.html</a></p> <p>[6] <a href="http://www.fenster-jancic.at/neu-4-fach-verglasung-isolierglas-ug-0-3-w-m2k/">www.fenster-jancic.at/neu-4-fach-verglasung-isolierglas-ug-0-3-w-m2k/</a></p> <p>[7] <a href="http://www.envirowindowsanddoors.co.uk/quadruple-glazing/#">www.envirowindowsanddoors.co.uk/quadruple-glazing/#</a></p> <p>[8] <a href="http://www.thespruce.com/argon-and-krypton-gas-in-windows-4060992">www.thespruce.com/argon-and-krypton-gas-in-windows-4060992</a></p> <p>[9] <a href="https://boavistawindows.com/pt/">https://boavistawindows.com/pt/</a></p>

### 3.1.2. Insulation + Façades

External Thermal Insulation Composite System (ETICS)	
<p><i>Description</i></p>	<p>ETICS stands for External Thermal Insulation Composite Systems and is the general denomination for external wall insulation systems consisting of several components, including the insulation material (commonly Expanded Polystyrene (EPS) or mineral wool), mechanical fixings, a mesh layer and a top-coat render and finishing.</p> <div data-bbox="470 526 1181 952" data-label="Diagram"> <p>The diagram illustrates the cross-section of an ETICS system. From left to right, the layers are: a concrete substrate wall, a layer of expanded polystyrene (EPS) insulation, a base coat of render, a layer of fibreglass mesh embedded in the render, an optional key coat, and a final thin acrylic-based finish coat. Mechanical fixings are shown securing the EPS board to the substrate.</p> </div> <p>Figure 2. Schematic of the composition of the system. Source: [1]</p> <p>These type of systems can be used to increase energy efficiency in new construction or renovation projects.</p> <p>Functionally, the primary purpose of ETICS is to assure thermal insulation and protection of the building against the weather, being particularly efficient in helping to avoid thermal bridges that occur when discontinuities exist in the building envelope materials that have different thermal conductivities, causing heat losses and associated pathologies. However, these systems are not responsible for guaranteeing airtightness [2].</p>
<p><i>Main characteristics</i></p>	<p>ETICS are generally composed of an insulation material (in the form of boards that can have some variation of density), which is attached to a support base, typically through adhesive. Reinforced rendering is used for external covering. The cladding used in these systems varies considerably. Synthetic resins and cement can be used, as well as tiles finishing.</p> <p>While the system consists of several prefabricated components being directly applied to the building façade, it is the harmonized planning and installation of all the components, materials and products that confer functionality to the building. There is, in consequence, the need to take special attention to transitions in specific sections, such as windows and doors.</p> <p>ETICS systems require conforming to a European Technical Assessment (ETA, as well as Construction Product Regulation (Regulation (EU) No 305/2011).).</p>

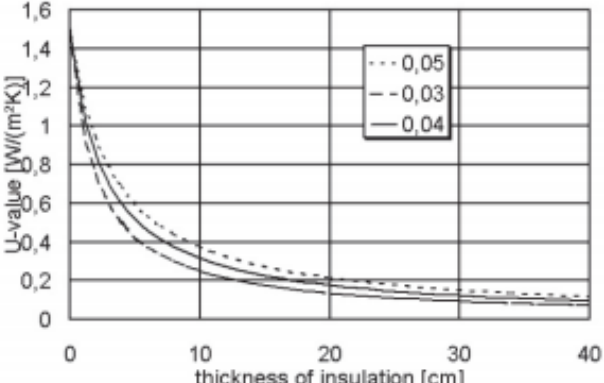
<i>Power range</i>	N/A																					
<i>Technology interdependencies</i>	Synergies with low temperature district heating systems and heat pumps as the added insulation means that lower temperatures are required from the heating system.																					
<i>Advantages and disadvantages</i>	<p>In general, ETICS systems present advantages in terms of cost and ease of application. In addition, these systems are extremely efficient in treating thermal bridges in the building envelope. Quality and durability of the system depend on the choice of the system components.</p> <p>There is potential for economies of scale when implemented in groups of buildings.</p> <p>As a disadvantage, the implementation of the system can alter the design of the façade, which can make it unsuitable for historic value buildings. In addition, ETICS system present durability problems, namely regarding low impact resistance.</p>																					
<i>Typical energy data and prices for ETICS solutions for one country</i>	 <p>Figure 3. Variation of U Value for an external wall after ETICS application considering different thermal conductivity insulation materials. Source: [3]</p> <p>Table 2. Prices and thermal information adapted of [4] and considering data from Portugal as a reference.</p> <table border="1" data-bbox="470 1422 1348 1803"> <thead> <tr> <th>System</th> <th>Thermal resistance (m<sup>2</sup>.K/W)</th> <th>Price (€/m<sup>2</sup>)</th> </tr> </thead> <tbody> <tr> <td>ETICS EPS 60mm</td> <td><b>4.032</b></td> <td>56.98</td> </tr> <tr> <td>ETICS EPS 90mm</td> <td><b>4.808</b></td> <td>63.76</td> </tr> <tr> <td>ETICS EPS 120mm</td> <td><b>5.618</b></td> <td>71.05</td> </tr> <tr> <td>ETICS Mineral Wool 40mm</td> <td><b>3.496</b></td> <td>62.05</td> </tr> <tr> <td>ETICS Mineral Wool 80mm</td> <td><b>4.545</b></td> <td>79.01</td> </tr> <tr> <td>ETICS Mineral Wool 120mm</td> <td><b>5.618</b></td> <td>96.97</td> </tr> </tbody> </table>	System	Thermal resistance (m <sup>2</sup> .K/W)	Price (€/m <sup>2</sup> )	ETICS EPS 60mm	<b>4.032</b>	56.98	ETICS EPS 90mm	<b>4.808</b>	63.76	ETICS EPS 120mm	<b>5.618</b>	71.05	ETICS Mineral Wool 40mm	<b>3.496</b>	62.05	ETICS Mineral Wool 80mm	<b>4.545</b>	79.01	ETICS Mineral Wool 120mm	<b>5.618</b>	96.97
System	Thermal resistance (m <sup>2</sup> .K/W)	Price (€/m <sup>2</sup> )																				
ETICS EPS 60mm	<b>4.032</b>	56.98																				
ETICS EPS 90mm	<b>4.808</b>	63.76																				
ETICS EPS 120mm	<b>5.618</b>	71.05																				
ETICS Mineral Wool 40mm	<b>3.496</b>	62.05																				
ETICS Mineral Wool 80mm	<b>4.545</b>	79.01																				
ETICS Mineral Wool 120mm	<b>5.618</b>	96.97																				
<i>Energy performance</i>	The insulation performance of an ETICS system is mostly dependent on the product that is used for the insulation layer. In a renovation intervention, research shows that the application of ETICS can lead to a 30% reduction in energy needs for heating and cooling [3].																					

<p><i>Financial data: investment, operation and maintenance</i></p>	<p>Costs are dependent on the material used. In particular, insulation material represents between 10-20% of the initial investment cost of the system. Considering an installation of the EPS system in a multi-story building, the average cost varies between 60-70 EUR/m<sup>2</sup> of the envelope.</p> <p>For Portugal, considering a non-insulated house, the application of ETICS systems has an average payback time of 8 years. The payback time depends on the energy price, the existing thermal transmittance and the overall physical condition of the building subjected to intervention [3].</p>
<p><i>Environmental issues</i></p>	<p>The most common insulation material used in the ETICS system is EPS, which is produced from non-renewable sources and using high energy intensity processes. In addition, there are also considerable amounts of polystyrene waste produced, in particular in the disposal phase of the lifecycle of the product. In order to avoid producing this kind of waste, the insulation material in an older ETICS system can be incorporated in a new system, in a process designated as “doubling up”.</p> <p>The life cycle assessment of a ETICS system can be calculated according to European harmonised standards, e.g. EN 15804 (Environmental System Declaration)</p>
<p><i>Development potential</i></p>	<p>Innovation regarding mechanization and prefabrication is expected in the development potential for ETICS systems. Mechanization would allow for faster implementation, savings in product leftovers and less labour. The prefabrication can be incorporated in any part of the ETICS system, with insulating panels and reinforcement prepared in factory with holes for anchors, as an example.</p> <p>In addition to the significant development potential in terms of improvement of the system itself (namely in terms of solving material heterogeneities within the system), there is potential also in the use of other thermal insulation materials. A current trend in research has been identified regarding the need for studying well-known insulation materials in the context of ETICS systems, as well as emerging high-performance insulation materials such as Phenolic Foam, Polyurethane Foam and Aerogel Mats [5].</p>
<p><i>References</i></p>	<p>[1] E. Barreira and V. P. de Freitas, “External Thermal Insulation Composite Systems: Critical Parameters for Surface Hygrothermal Behaviour,” <i>Adv. Mater. Sci. Eng.</i>, vol. 2014, pp. 1–16, Feb. 2014.</p> <p>[2] EAE, “European Association for ETICS.” [Online]. Available: <a href="https://www.ea-etics.eu/home/">https://www.ea-etics.eu/home/</a>. [Accessed: 19-Mar-2019].</p> <p>[3] F. Wetzel, C.; Vogdt, “Technical Improvement of Housing Envelopes in Germany,” in , <i>Improving the Quality of Existing Urban Building Envelopes – Façades and roofs</i>, C. . Bragança, L.; Wetzel and L. G. . Buhagiar, V.; Verhoef, Eds. IOS Press BV I, 2007, pp. 46–48.</p> <p>[4] S. A. CYPE Ingenieros, “Gerador de Preços. Portugal,” 2018. .</p> <p>[5] Foambuild, “Functional Adaptive Nano-Materials and Technologies for Energy Efficient Buildings.” [Online]. Available: <a href="http://www.foambuild.eu/">http://www.foambuild.eu/</a>. [Accessed: 19-Mar-2019].</p>

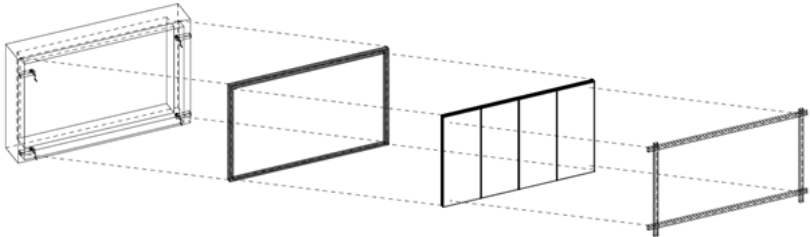
<b>Modular Façade Panels</b>	
<i>Description</i>	<p>Modular Façade Panels are prefabricated composite systems ready to be applied in existing external walls. They are generally composed of a layered structure with a cladding surface and an interior insulation material. The system allows integrating complementary technologies such as monitoring devices and the use of 3D printing and scanning.</p>  <p>Figure 4. Schematic of a generic modular panel assembly Source: adapted from [1].</p> <p>Although the industrialised process in Europe for new constructions can be considered to be mature, there are opportunities to take advantage of the knowledge and competences developed in these processes, such as automated production lines, business models and cost optimisation, in order to tackle the challenge of deep renovation in the existing building stock. In this context, there is the need to adapt and transfer the skills acquired for new construction to the industrialization approach for energy renovations [2].</p>
<i>Main characteristics</i>	<p>Modular façade panels combine an insulation layer with a coating material, which can be customized according to the needs of the project. There is the obvious need to use auxiliary elements for fixing the system to the existing walls of the building for stability. The most common elements are anchorage, profiles and rails. Because the use of such elements interrupt the continuity of the thermal insulation, they can cause a detrimental effect on thermal performance, namely through the increase of thermal bridges, which makes some systems predict an additional layer of insulation serving as the interface between the modular panel and the existing wall of the building. Additional information can be found in the More Connect project reports [3], in the IEA EBC Annex 50 [4] and Energiesprong [5].</p>
<i>Power range</i>	N/A
<i>Technology interdependencies</i>	<p>Synergies with low temperature district heating systems and heat pumps as the added insulation means that lower temperatures are required from the heating system. PV and Solar Thermal panels can be incorporated in the modular façade panels.</p>
<i>Advantages and disadvantages</i>	<p>The modular façade panels have advantages concerning deep retrofitting approach including: reduced time of application with minimal disturbance of occupants; improved energy efficiency with a lower environmental impact; high level of customization; potential economies of scale when applied in groups of buildings.</p> <p>By the other hand, modularity of the concept can limit the implementation in historic buildings.</p>

<p><i>Typical energy data and prices for MFP solutions for one country</i></p>	<p>Table 3. Data from More-Connect project [1], considering the effect on a current construction solution (double 11 cm hollow brick wall with no insulation) in Portugal.</p> <table border="1" data-bbox="469 342 1388 1070"> <thead> <tr> <th></th> <th>Thickness (cm)</th> <th>U – Value (W/m<sup>2</sup>.K)</th> <th>Price (€/m<sup>2</sup>)</th> </tr> </thead> <tbody> <tr> <td>Modular Façade Panel</td> <td>12</td> <td>0.30</td> <td>52.00</td> </tr> <tr> <td rowspan="3">Additional insulation of Mineral wool of 25 kg/m<sup>3</sup></td> <td>6</td> <td>0.20</td> <td>55.22</td> </tr> <tr> <td>8</td> <td>0.18</td> <td>56.22</td> </tr> <tr> <td>10</td> <td>0.17</td> <td>57.46</td> </tr> <tr> <td rowspan="4">Additional insulation of Mineral wool of 40 kg/m<sup>3</sup></td> <td>6</td> <td>0.20</td> <td>58.29</td> </tr> <tr> <td>7</td> <td>0.19</td> <td>59.41</td> </tr> <tr> <td>8</td> <td>0.18</td> <td>60.53</td> </tr> <tr> <td>10</td> <td>0.16</td> <td>62.77</td> </tr> <tr> <td rowspan="3">Additional insulation of Mineral wool of 50 kg/m<sup>3</sup></td> <td>6</td> <td>0.20</td> <td>58.58</td> </tr> <tr> <td>8</td> <td>0.18</td> <td>60.98</td> </tr> <tr> <td>10</td> <td>0.16</td> <td>63.38</td> </tr> <tr> <td rowspan="3">Additional insulation of Mineral wool of 70 kg/m<sup>3</sup></td> <td>6</td> <td>0.20</td> <td>62.50</td> </tr> <tr> <td>8</td> <td>0.18</td> <td>66.00</td> </tr> <tr> <td>10</td> <td>0.16</td> <td>69.50</td> </tr> </tbody> </table>		Thickness (cm)	U – Value (W/m <sup>2</sup> .K)	Price (€/m <sup>2</sup> )	Modular Façade Panel	12	0.30	52.00	Additional insulation of Mineral wool of 25 kg/m <sup>3</sup>	6	0.20	55.22	8	0.18	56.22	10	0.17	57.46	Additional insulation of Mineral wool of 40 kg/m <sup>3</sup>	6	0.20	58.29	7	0.19	59.41	8	0.18	60.53	10	0.16	62.77	Additional insulation of Mineral wool of 50 kg/m <sup>3</sup>	6	0.20	58.58	8	0.18	60.98	10	0.16	63.38	Additional insulation of Mineral wool of 70 kg/m <sup>3</sup>	6	0.20	62.50	8	0.18	66.00	10	0.16	69.50
	Thickness (cm)	U – Value (W/m <sup>2</sup> .K)	Price (€/m <sup>2</sup> )																																																	
Modular Façade Panel	12	0.30	52.00																																																	
Additional insulation of Mineral wool of 25 kg/m <sup>3</sup>	6	0.20	55.22																																																	
	8	0.18	56.22																																																	
	10	0.17	57.46																																																	
Additional insulation of Mineral wool of 40 kg/m <sup>3</sup>	6	0.20	58.29																																																	
	7	0.19	59.41																																																	
	8	0.18	60.53																																																	
	10	0.16	62.77																																																	
Additional insulation of Mineral wool of 50 kg/m <sup>3</sup>	6	0.20	58.58																																																	
	8	0.18	60.98																																																	
	10	0.16	63.38																																																	
Additional insulation of Mineral wool of 70 kg/m <sup>3</sup>	6	0.20	62.50																																																	
	8	0.18	66.00																																																	
	10	0.16	69.50																																																	
<p><i>Energy performance</i></p>	<p>Research shows that the implementation of a modular approach to deep renovation in buildings envelope in Portugal can help achieve a 25% reduction in the energy needs for heating and cooling [1]. Depending on the local context, including the climate context, different results can be achieved.</p>																																																			
<p><i>Financial data: investment, operation and maintenance</i></p>	<p>Examples in Europe demonstrate that in some cases and at an early stage of development, the modular façade panels can present higher costs than those of the traditional renovation solutions (e.g. ETICS). However, the possibility of up-scaling and optimizing industrial processes, can lead to a cost reduction in order to achieve cost-effectiveness. In Portugal, it was found that the optimization of the production process can reduce costs up to 70% [6].</p>																																																			
<p><i>Environmental issues</i></p>	<p>The environmental impact of the modular façade panels is directly related with the materials composing the system [7].</p> <p>There are significant efforts to design modules with low embodied energy using materials like timber and recycled materials.</p>																																																			
<p><i>Development potential</i></p>	<p>There is potential for customisation of the prefabricated modular systems in order to accommodate more specificities of the project, including the integration of PV and Solar Thermal technology, which provide the opportunity for the development of solar façades with the ability to reutilize solar heat [8]</p>																																																			

	<p>There is also evidence that there will be an increase in the use of innovative technologies such as robotics and 3D-scans, which can bring significant advantages to this type of technology [2].</p> <p>The use of modular systems opens up space for innovative business models, such as one-stop-shops for energy renovation of buildings, which aims to facilitate an integrated response to the process of intervening a building in order to improve its energy performance.</p>
<p><i>References</i></p>	<p>[1] More-Connect, "Development and advanced prefabrication of innovative, multifunctional building envelope elements for modular retrofitting and smart connections." [Online]. Available: <a href="https://www.more-connect.eu/">https://www.more-connect.eu/</a>. [Accessed: 19-Mar-2019].</p> <p>[2] BPIE, "Driving transformational change in the construction value chain," 2016.</p> <p>[3] <a href="http://www.more-connect.eu">www.more-connect.eu</a></p> <p>[4] <a href="http://www.iea-ebc.org/projects/project?AnnexID=50">http://www.iea-ebc.org/projects/project?AnnexID=50</a></p> <p>[5] <a href="https://energiesprong.org">https://energiesprong.org</a></p> <p>[6] M. Almeida and R. Barbosa, "the more-connect: concepts of renovation packages," in a guide into renovation package concepts for mass retrofit of different types of buildings with prefabricated elements for (n)zeb performance, huygen/ribuilt-sbs/zuyd, 2018.</p> <p>[7] M. Almeida, R. Barbosa, and R. Malheiro, "Effect of environmental assessment on primary energy of modular prefabricated panel for building renovation in Portugal," IOP Conf. Ser. Earth Environ. Sci., vol. 225, no. 1, p. 012047, Feb. 2019.</p> <p>[8] Lai, C., Hokoi, S., "Solar façades: A review". Building and Environment, v. 91, p. 152–165, Set. 2015.</p>

<b>Opaque Ventilated Façade</b>	
<i>Description</i>	<p>An opaque ventilated façade (OVF) is a construction method whereby a physical separation is created between the outside of the façade and the internal wall of the building. This separation creates an open cavity allowing the exchange of the air contained between the wall and the outer cladding. The cavity can provide a range of thermal, acoustic, aesthetic and functional advantages.</p> <p>The main difference in the thermal and energy analysis between a conventional façade and a ventilated system is the specific phenomena that occurs inside the ventilated air cavity. The ventilated air cavity plays an important role not only in the thermal performance of the wall, but also in its hydrothermal performance. Apart from the conduction and radiation heat transfer processes, natural convection is one of the main processes of heat transfer that affects OVF behaviour. Natural ventilation can be the consequence of two phenomena: buoyancy and wind.</p> <p>Many studies show that the incorporation of an insulated ventilated façade always involves energy savings compared to a conventional façade with no thermal insulation. But, in general terms, one of the main interests in OVFs is their ability to reduce cooling thermal loads, which is interesting especially in warm areas where cooling demands are high, whereas the ventilation could carry a negative effect in areas where heat demand is high. Then, as several authors agree, OVF works as a passive cooling strategy during the summer, especially in those orientations that receive solar radiation (South, East and West). It is possible to assert that the ventilated façades achieve high energy performances during the summer period, with a reduction of the incoming heat flux typically above 40%, compared to the same, but unventilated, façade.</p> <p>*The main part of the description and main features presented in this section has been taken from Ibañez-Puy, M. et al (2017). <i>Opaque Ventilated Façades: Thermal and energy performance review</i>. <i>Renewable and Sustainable Energy Reviews</i>, 79, 180-191.</p>



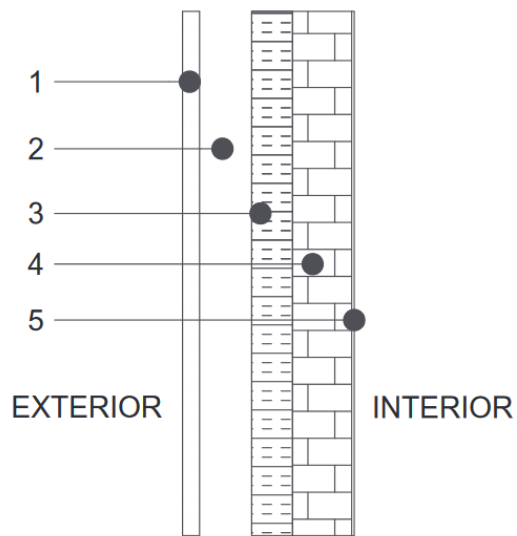

Figure 5. Schematic section of a ventilated façade (figure obtained from Diarce, G. et al. (2013) Ventilated active façade with PCM. Applied Energy, 109, 530-537). 1-new cladding, 2-ventilated cavity, 3-added insulation, 4-original brick wall, 5-internal layer.

<p><i>Main characteristics</i></p>	<p>The addition of insulation reduces the overall U-value, and thereby the heat loss through the façade, significantly. Moreover, since thermal insulation is installed from the outside, thermal breaks in façade are avoided.</p> <p>On the other hand, the outer layer can reduce significantly the solar gains in the façade, becoming a passive strategy aimed to reduce the cooling loads in summer.</p>
<p><i>Power range</i></p>	<p>N/A</p>
<p><i>Technology interdependencies</i></p>	<p>Adding an OVF onto a non-insulated façade will reduce the heat loss from a building. Moreover, due to aforementioned features, the reduction of cooling load by reducing solar gains will be noticeable.</p> <p>OVF could thereby be part of an overall reduction of the heating and (especially) cooling requirements that could result in a downscaling of the HVAC system.</p>
<p><i>Advantages and disadvantages</i></p>	<p>In general, OVF presents good performance both for reducing heating and cooling demand. In warm climates, the ventilated air cavity allows reducing solar gains during summer. There is potential economies of scale when implemented in groups of buildings. The OVF solution can present higher cost than other solutions, such as ETICS. There are evidences highlighting the need for a careful design of the OVF solution depending on the type of climate. In hot weather, when solar radiation is also high, there is the possibility of increased heat gains indoors. On the other hand, in colder climates, if solar radiation and exterior air</p>

	temperature are low, an OVF can present a negative energy balance, harming indoor conditions and increasing the demand for energy [1] [2].																					
<i>Typical energy data and prices for window solutions for one country</i>	<p>The cost of an Opaque Ventilated Façade (OVF) varies significantly depending on its features, especially those related to the material of outer cladding. As a reference, range can be 100-150 €/m<sup>2</sup> (cost in Spain, including labour cost). An average reference value will be assumed, considering a ventilated façade cladding system made of High Pressure laminates (HPL), and Rockwool panels.</p> <p><u>Table 4. Costs and lifetime of typical OVF (source: <a href="http://www.generadordeprecios.info/">http://www.generadordeprecios.info/</a>)</u></p> <table border="1"> <thead> <tr> <th>OVF (Based on mineral wool) insulation (cm) (0.035 W/mK)</th> <th>4</th> <th>6</th> <th>8</th> <th>10</th> <th>12</th> <th>14</th> </tr> </thead> <tbody> <tr> <td>Cost [€/m<sup>2</sup>]</td> <td>135</td> <td>137</td> <td>139</td> <td>141</td> <td>143</td> <td>146</td> </tr> <tr> <td>Lifetime [years]</td> <td>25</td> <td>25</td> <td>25</td> <td>25</td> <td>25</td> <td>25</td> </tr> </tbody> </table>	OVF (Based on mineral wool) insulation (cm) (0.035 W/mK)	4	6	8	10	12	14	Cost [€/m <sup>2</sup> ]	135	137	139	141	143	146	Lifetime [years]	25	25	25	25	25	25
OVF (Based on mineral wool) insulation (cm) (0.035 W/mK)	4	6	8	10	12	14																
Cost [€/m <sup>2</sup> ]	135	137	139	141	143	146																
Lifetime [years]	25	25	25	25	25	25																
<i>Energy performance</i>	The U-value of the façade will depend on the thermal insulation added. The cooling effect linked to the ventilated air gap is more complex to calculate, though simplified methods to consider it can be found in literature, e.g. [3].																					
<i>Financial data: investment, operation and maintenance</i>	An OVF typically costs 100-150 €/m <sup>2</sup> in Spain, and the expected lifetime varies depending on the materials used, but can be assumed as a reference up to 25 years. Maintenance costs will depend mainly on the external cladding installed.																					
<i>Environmental issues</i>	The production of aluminium substructure is an energy intensive process contributing to adverse effects on climate. Effects can be reduced significantly by using recycled metals in production and ensuring a design in which aluminium profiles can be reused or recycled at the end of the façade service life or timber construction is used. The selection of outer cladding material (which has a negligible effect when only thermal performance of the façade is considered) will have different environmental effects depending on the material selected.																					
<i>Development potential</i>	Due to its flexibility, it can be applied in different situations and using conventional method or innovative technologies and systems (e.g. vacuum insulated panels instead of conventional thermal insulation, active OVF with PV etc.)																					
<i>References</i>	[1] Ibañez-Puy, M. et al (2017). Opaque Ventilated Façades: Thermal and energy performance review. Renewable and Sustainable Energy Reviews, 79, 180-191. <a href="https://doi.org/10.1016/j.rser.2017.05.059">https://doi.org/10.1016/j.rser.2017.05.059</a>																					

### 3.1.3. Decentralised ventilation system with heat recovery

<b>Decentral ventilation system with heat recovery</b>	
<p><i>Description</i></p>	<p>A balanced mechanical ventilation system ensures an adequate air exchange to achieve good air quality. When adding a heat recovery unit this can be achieved with low heat losses. Mechanical ventilation can be installed by either setting up a ventilation system centrally in the property or by a decentralised ventilation system in each apartment.</p> <p>Normally, central solutions consist of single air-handling units for several apartments. The ventilation unit is typically located in a separate room, either on the roof or in the basement. In a decentralised solution, a ventilation unit is placed in each apartment. There are several principles for decentralised solutions. The following description deals with decentralised ventilation through the façade with a constant airflow.</p> <p>This solution of decentralised ventilation is a full individual ventilation system in each flat with inlet and outlet through the facade and heat recovery inside the flat. A decentralised ventilation system in combination with a hybrid solution, where the mechanical ventilation is stopped during summer resulting in lower electricity consumption. The lower electricity consumption comes partly from the short ducts and partly from the summer stop. Additionally, it is possible to make the ventilation better fitted to the individual flat.</p> <p>During winter, the systems are controlled individually by the moisture content in each flat, with minimum airflow to ensure adequate indoor climate. As an example, in Denmark the minimum required airflow is fixed at 0.3 l/s per m<sup>2</sup> floor space equal to approx. 0.5 air changes per hour for residential buildings.</p> <p>It is possible during summer, that natural ventilation is used instead and the mechanical system is only turned on by passive infrared sensors (PIR) in the bathroom if the cooker hood (integrated part of the ventilation system) is turned on. The latter needs a dispensation from the local authorities in many countries.</p>
<p><i>Main characteristics</i></p>	<p>An example of a solution requiring less ducts is a system, based on pulsing supply and exhaust in each room and a capacity heat recovery unit. The manufacturer claims a very high heat recovery efficiency up to 91% - similar to the best central systems at an air flowrate corresponding to approx. 0.3 l/s pr. m<sup>2</sup> floor area. The system is a double system with an inlet/outlet and an outlet/inlet unit. The airflow changes direction every 70 seconds and heat is recovered from a thermal mass located in each unit.</p>



Figure 6. Decentral heat recovery unit.

The technology is based on innovative components reducing noise, optimising airflow and recovering heat in a compact design. Manufacturers are making huge efforts to reduce noise and drafts, as this is often a big problem.

Ventilation with heat recovery is particularly relevant to consider in the following situations:

- If mould has occurred in the apartment (may often be due to lack of ventilation)
- In connection with energy renovations, for example facade renovation and window replacement
- In cold climates, where draft problems can occur.

Decentralised ventilation is often used in situations where the space for ducts is limited and there is no existing ducts beforehand.

*Power range*

As an example the heat recovery unit SmartFan can have quite high efficiencies and below is an example of power range and more:

Table 5. Power range and noise for SmartFan heat recovery unit.

		<b>Level 1</b>	<b>Level 2</b>	<b>Level 3</b>	<b>Level 4</b>
<b>Air flow volume</b>	m <sup>3</sup> /h	18	28	38	46
<b>Sound pressure level<sup>1)</sup></b>	db(A)	11	19	28	33
<b>Power consumption<sup>2)</sup></b>	W	0.8	1.4	2.6	4.0
Standardised sound level 44/49 DB					
Core –drilled hole diameter 162 mm					

<sup>1)</sup> operating in pairs

<sup>2)</sup> without power supply

*Technology interdependencies*

Good ventilation is more than just having fresh air. It is fundamental to feeling good at home. Security and protection are often underestimated as positive aspects of decentralized home ventilation. Furthermore, decentralised ventilation provides optimal ventilation, while at the same time shutting out noise. Especially in residential areas with high noise pollution, for instance near airports, railways or main roads, installation of a decentralized ventilation unit significantly upgrades a building. The heat recovery system

	is part of an overall reduction of the heating requirement that could result in a downscaling of the heating system.																																	
<i>Advantages and disadvantages</i>	<p>Advantages and disadvantages for decentral, hybrid ventilation with heat recovery:</p> <ul style="list-style-type: none"> <li>• This solution requires less space for vertical ducts, hence leaving more space that is habitable for the same gross floor area.</li> <li>• The solution takes up no area on the roof, which can, for example, then be used for harvesting renewable energy.</li> <li>• No risk of transferring smell from one flat to another as the different ventilation systems are disconnected.</li> <li>• Less consumption of electricity for air movements due to shorter ducts and summer cut-stop of the mechanical ventilation.</li> <li>• Exhaust air from bathroom and toilets often have special requirements and have to be let above the roof (e.g. in Denmark and Norway).</li> <li>• Location of the heat recovery unit inside the different flats, entail increased disturbance of the residents for maintenance or leaves maintenance to the residents themselves.</li> <li>• Placement of fans inside the flats requires extra consciousness in the design to avoid noise nuisance for the residents.</li> <li>• Inlets, outlets, and windows in the building needs to be located with care to avoid transfer of odours form one flat to another.</li> <li>• Pollution from outside can be a problem.</li> </ul>																																	
<i>Typical energy data and prices for ventilation system</i>	<p>Below is a Danish apartment showing the yearly energy saving by changing natural mechanical ventilation to decentral ventilation with heat recovery. Specific Fan Power (SFP) is a parameter that quantifies the energy-efficiency of fan air movement systems.</p> <p>Table 6. Exemplary Data from Denmark taken from <a href="https://www.byggeriogenergi.dk/">https://www.byggeriogenergi.dk/</a>.</p> <table border="1" data-bbox="470 1167 1426 1877"> <thead> <tr> <th data-bbox="470 1167 783 1249"><b>Existing ventilation system</b></th> <th data-bbox="783 1167 943 1249"><b>Apartment area</b></th> <th colspan="2" data-bbox="943 1167 1426 1249"><b>New decentral ventilation system</b></th> </tr> </thead> <tbody> <tr> <td data-bbox="470 1249 783 1424"></td> <td data-bbox="783 1249 943 1424">Apartment area</td> <td data-bbox="943 1249 1182 1424">Min. heat recovery = 80% Heating savings in kWh/year</td> <td data-bbox="1182 1249 1426 1424">Min. heat recovery = 85% Heating savings in kWh/year</td> </tr> <tr> <td data-bbox="470 1424 783 1514" rowspan="2">Natural or mech. exhaust air</td> <td data-bbox="783 1424 943 1469">60</td> <td data-bbox="943 1424 1182 1469">3640</td> <td data-bbox="1182 1424 1426 1469">3870</td> </tr> <tr> <td data-bbox="783 1469 943 1514">100</td> <td data-bbox="943 1469 1182 1514">3640</td> <td data-bbox="1182 1469 1426 1514">3870</td> </tr> <tr> <td data-bbox="470 1514 783 1688"></td> <td data-bbox="783 1514 943 1688">Apartment area</td> <td data-bbox="943 1514 1182 1688">SFP = 1000 J/m<sup>3</sup> More electricity consumption kWh/year</td> <td data-bbox="1182 1514 1426 1688">SFP = 800 J/m<sup>3</sup> More electricity consumption kWh/year</td> </tr> <tr> <td data-bbox="470 1688 783 1778" rowspan="2">Natural ventilation</td> <td data-bbox="783 1688 943 1733">60</td> <td data-bbox="943 1688 1182 1733">307</td> <td data-bbox="1182 1688 1426 1733">245</td> </tr> <tr> <td data-bbox="783 1733 943 1778">100</td> <td data-bbox="943 1733 1182 1778">307</td> <td data-bbox="1182 1733 1426 1778">245</td> </tr> <tr> <td data-bbox="470 1778 783 1868" rowspan="2">Mechanical exhaust air</td> <td data-bbox="783 1778 943 1823">60</td> <td data-bbox="943 1778 1182 1823">0</td> <td data-bbox="1182 1778 1426 1823">-61</td> </tr> <tr> <td data-bbox="783 1823 943 1868">100</td> <td data-bbox="943 1823 1182 1868">0</td> <td data-bbox="1182 1823 1426 1868">-61</td> </tr> </tbody> </table> <p>The price for the SmartFan system is approx. 20-25,000 DKK / 3067 EUR for 100 m<sup>2</sup> apartment which correspond to 8 units.</p>	<b>Existing ventilation system</b>	<b>Apartment area</b>	<b>New decentral ventilation system</b>			Apartment area	Min. heat recovery = 80% Heating savings in kWh/year	Min. heat recovery = 85% Heating savings in kWh/year	Natural or mech. exhaust air	60	3640	3870	100	3640	3870		Apartment area	SFP = 1000 J/m <sup>3</sup> More electricity consumption kWh/year	SFP = 800 J/m <sup>3</sup> More electricity consumption kWh/year	Natural ventilation	60	307	245	100	307	245	Mechanical exhaust air	60	0	-61	100	0	-61
<b>Existing ventilation system</b>	<b>Apartment area</b>	<b>New decentral ventilation system</b>																																
	Apartment area	Min. heat recovery = 80% Heating savings in kWh/year	Min. heat recovery = 85% Heating savings in kWh/year																															
Natural or mech. exhaust air	60	3640	3870																															
	100	3640	3870																															
	Apartment area	SFP = 1000 J/m <sup>3</sup> More electricity consumption kWh/year	SFP = 800 J/m <sup>3</sup> More electricity consumption kWh/year																															
Natural ventilation	60	307	245																															
	100	307	245																															
Mechanical exhaust air	60	0	-61																															
	100	0	-61																															

<p><i>Energy performance</i></p>	<p>Ventilation in buildings with flats are typically built as mechanical extraction or as natural ventilation without heat recovery. Since the existing ventilation is without heat recovery, heat is lost corresponding to up to 30% of the buildings total energy consumption for space heating.</p> <p>The heat recovery unit can have quite high efficiencies similar to the best central systems and 91% should be a realistic number according to the manufacturer. Due to the short ducts, the specific fan power consumption can be kept low, and typical values are found below 1000 J/m<sup>3</sup> outside air.</p>
<p><i>Financial data: investment, operation and maintenance</i></p>	<p>Decentralised ventilation is cheap compared to central systems due to the reduced ductwork. However, the number of fans increases followed by increased cost. Additionally, maintenance is more complicated and costly compared to a central system.</p>
<p><i>Environmental issues</i></p>	<p>Metals and insulation used in the ventilation units such as aluminium and stainless steel sheets as well as EPS insulation are produced through highly energy intensive processes contributing to adverse effects on climate. The effects can be reduced by using recycled metals in production as well as insuring a design, where the metals can be reused or recycled at the end of the units' service life.</p>
<p><i>Development potential</i></p>	<p>Research for more energy efficient HVAC systems is going on which include nano-technological coatings and surface treatments for improved heat transfer; new nano- and micro-materials for improved efficiency of the refrigerants, and improved efficiency and heat transfer capabilities of coolants via new nano-technological additives.</p> <p>Furthermore, research is going on to integrate heat recovery technology into passive ventilation systems. In addition, research for combined systems with advanced control algorithms for optimization will be further developed.</p>
<p><i>References</i></p>	<p>[1] <a href="http://www.movair.dk/forside-nyhed/103-nyt-movair-produkt-der-vil-revolutionere-markedet-for-decentral-boligventilation.html">www.movair.dk/forside-nyhed/103-nyt-movair-produkt-der-vil-revolutionere-markedet-for-decentral-boligventilation.html</a></p> <p>[2] <a href="http://www.getair.eu/dk/">www.getair.eu/dk/</a></p> <p>[3] <a href="http://www.sciencedirect.com/science/article/pii/S1364032115011181">www.sciencedirect.com/science/article/pii/S1364032115011181</a></p> <p>[4] <a href="http://www.dti.dk/specialists/new-technology-can-save-millions-in-cooling-and-ventilation/32792">www.dti.dk/specialists/new-technology-can-save-millions-in-cooling-and-ventilation/32792</a></p> <p>[5] <a href="http://thermaflex.com/dk/systemer/rorkanaler">thermaflex.com/dk/systemer/rorkanaler</a></p> <p>[6] <a href="http://www.byggeriogenergi.dk/media/1788/decentral-ventilation-med-varmegenvinding_ok.pdf">www.byggeriogenergi.dk/media/1788/decentral-ventilation-med-varmegenvinding_ok.pdf</a></p>

### 3.1.4. Shading systems

Shading systems	
<p><i>Description</i></p>	<p>The first step of any cooling strategy is protection of the building from unwanted solar gain and this is most readily achieved by blocking the sun's rays before they reach the building. Shading and windows can operate in a synergic strategy dosing heat and light reaching the core of a building. The primary function of windows is to allow daylight into the building. Solar shading is an effective way to control the internal conditions inside living spaces limiting excessive solar heat gain and solar glare. Ideal shading system has to control the solar radiation but not prevent daylight, outside view and natural ventilation.</p> <p>For southern European climates, the primary challenge of shading systems is to allow the daylight to enter while at the same time reducing the solar irradiation to avoid compromising the indoor climate (prevent overheating).</p> <p>For the northern European countries, because of the higher frequency of hours with sun which stands at a normal position to the window, the primary challenge is limiting glare problem allowing solar radiation to flow into the building.</p> <p>Orientation and latitude of the site define the design parameter of the shading system. Varying the sun position in the sky the optimum characteristics of shading systems vary with season and daytime.</p>
	<p>Figure 7. Example of sun –path diagram for latitude 52°N.</p>
	<p>A wide range of options are available with various configurations, materials, finishes to meet the requirements of the specific situation. Different manufacturers exist and the shading systems build-up varies. Shading devices may be external or internal, fixed or moveable.</p>

Fixed horizontal solar shading performs well on a South facing façade. In the same way vertical fixed shading performance are good on an East or West facing facade, which receives a large amount of sunshine during the day. A controllable shading system can optimize the performances of shading, but a sun tracking system is necessary. Often seasonal manual adjusting is adopted and obtains good results.

A common classification of shading devices is based on their position respect to the fenestration, obtaining external and internal shading.

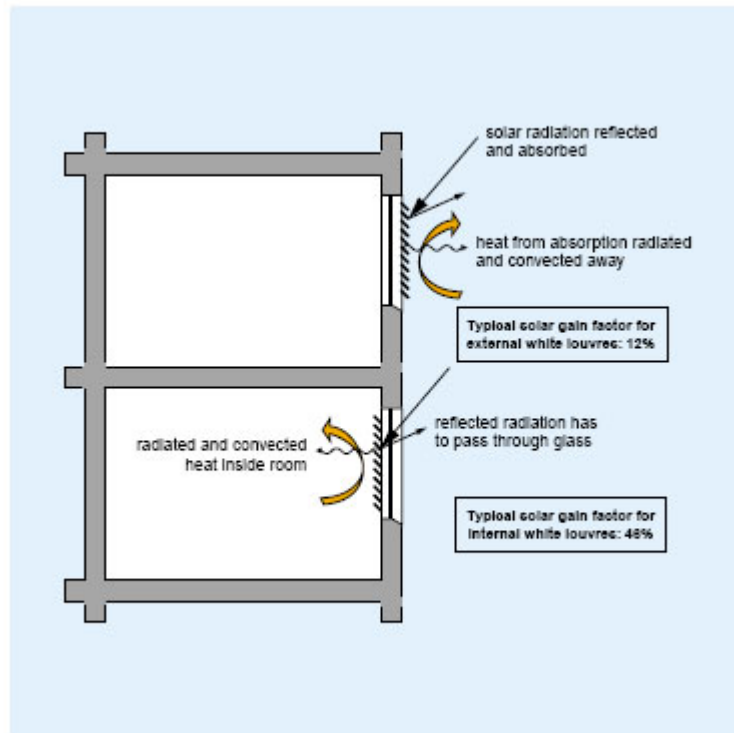
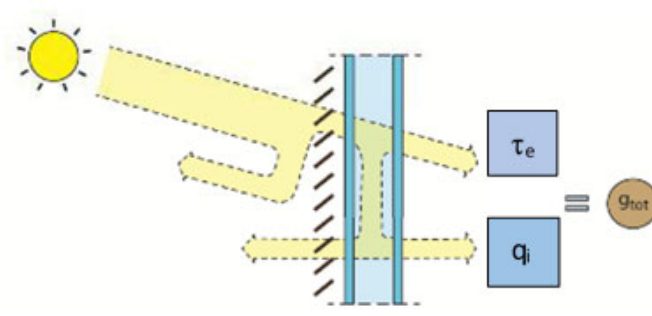

Figure 8. External versus Internal shading systems.

An **external shading system** allows a higher total shading performance. In fact, by intercepting solar radiation before the glazing it is able to stop a greater part of it and, above all, in an external environment it is able to dissipate better the greater quantities of energy eventually absorbed. This technique obtains a solar factor  $g_{tot}$  in the range of 0.10 – 0.30. Exterior systems are usually more expensive as they are exposed to climate agents and require durable material and stiff installation.

Alternatively, and where it is not practicable to install an external shield, you can opt for an **internal shading** near the glass. This design solution offers installation versatility, and generally less expensive maintenance than an external one. This technique obtains a solar factor  $g_{tot}$  in the range 0.40 – 0.65.



	<p>It is possible to integrate photovoltaic cells into the shading systems so as to generate electricity at the same time as providing shading. Both monocrystalline and polycrystalline cells may be used.</p>
<p><i>Main characteristics</i></p>	<p>Total solar heat gain (TSHG or <math>g_{tot}</math>), is the ratio between the solar heat flux transmitted globally through the system glazing plus shading and the incident solar heat flux on the outside surface of the system (values in the range 0-1).</p> <p>The performance of a shading system depends both on the direct transmission, <math>\tau_e</math>, and on the portion of solar energy absorbed by the shading and reemitted in the unit of time towards the interior, <math>q_i</math>, secondary radiation or indirect. To calculate the <math>g_{tot}</math>. The components of the energy exchange must be added:</p> $g_{tot} = \tau_e + q_i$  <p>Figure 9. Scheme of energy flux giving origin to g factor following standard EN 13363-1</p> <p><b>Shading coefficient Fc or SC</b></p> <p>Similarly to the coefficient relative to the single glasses, Fc expresses the relationship between the Solar Factor <math>g_{tot}</math> of a given shielding system together with glazing and the Solar Factor <math>g_v</math> of the glazing system alone (EN 13561 and EN 13569).</p>
<p><i>Power range</i></p>	<p>N/A</p>
<p><i>Technology interdependencies</i></p>	<p>Installing a shading system in front of a window will significantly reduce the heat load during summer for a building, while maintaining similar characteristics regarding light and solar energy transmission during wintertime. Shading systems will be most relevant to use in climates dominated by cooling demands and less in climates dominated by heating demands.</p>

	Shading systems could be part of an overall reduction of the cooling requirement that could result in a downscaling of the cooling system or a transition to high temperature district cooling for example.																																												
<i>Advantages and disadvantages</i>	<p>Shading systems contribute to reduce excessive glare in northern countries and overheating in southern countries. Furthermore, shading systems can reduce the transmission heat loss through the glazed areas approximately in a range from 10% to 90%.</p> <p>A good design of the system can maintain daylight levels and solar energy gains during winter.</p> <p>A wide range of options are available with various configurations, the cost is variable as a consequence. The costs are approximately 20-50% higher compared to a simple glazing system.</p>																																												
<i>Typical energy data for shading systems</i>	<table border="1"> <thead> <tr> <th><i>Fenestration</i></th> <th><i>SC</i></th> <th><i>Fenestration</i></th> <th><i>SC</i></th> </tr> </thead> <tbody> <tr> <td>regular DS single glass</td> <td>1.00</td> <td>white venetian blind full down</td> <td>0.55</td> </tr> <tr> <td>inside dark shade half down</td> <td>0.90</td> <td>light gray drapery closed</td> <td>0.47</td> </tr> <tr> <td>regular double glass</td> <td>0.85</td> <td>light-reflecting film on glass</td> <td>varies</td> </tr> <tr> <td>inside medium shade half down</td> <td>0.81</td> <td>inside white shade full down</td> <td>0.40</td> </tr> <tr> <td>inside dark shade full down</td> <td>0.81</td> <td>off-white drapery closed</td> <td>0.40</td> </tr> <tr> <td>regular triple glass</td> <td>0.75</td> <td>outside vert fins on E and W</td> <td>0.30</td> </tr> <tr> <td>inside light shade full down</td> <td>0.70</td> <td>horizontal overhang on south</td> <td>0.25</td> </tr> <tr> <td>1/4" heat absorbing glass</td> <td>0.66</td> <td>tree providing heavy shade</td> <td>0.25</td> </tr> <tr> <td>dark gray drapery closed</td> <td>0.58</td> <td>outside dark canvas awning</td> <td>0.15</td> </tr> <tr> <td>tree providing light shade</td> <td>0.55</td> <td>outside adjustable louvers</td> <td>0.15</td> </tr> </tbody> </table>	<i>Fenestration</i>	<i>SC</i>	<i>Fenestration</i>	<i>SC</i>	regular DS single glass	1.00	white venetian blind full down	0.55	inside dark shade half down	0.90	light gray drapery closed	0.47	regular double glass	0.85	light-reflecting film on glass	varies	inside medium shade half down	0.81	inside white shade full down	0.40	inside dark shade full down	0.81	off-white drapery closed	0.40	regular triple glass	0.75	outside vert fins on E and W	0.30	inside light shade full down	0.70	horizontal overhang on south	0.25	1/4" heat absorbing glass	0.66	tree providing heavy shade	0.25	dark gray drapery closed	0.58	outside dark canvas awning	0.15	tree providing light shade	0.55	outside adjustable louvers	0.15
<i>Fenestration</i>	<i>SC</i>	<i>Fenestration</i>	<i>SC</i>																																										
regular DS single glass	1.00	white venetian blind full down	0.55																																										
inside dark shade half down	0.90	light gray drapery closed	0.47																																										
regular double glass	0.85	light-reflecting film on glass	varies																																										
inside medium shade half down	0.81	inside white shade full down	0.40																																										
inside dark shade full down	0.81	off-white drapery closed	0.40																																										
regular triple glass	0.75	outside vert fins on E and W	0.30																																										
inside light shade full down	0.70	horizontal overhang on south	0.25																																										
1/4" heat absorbing glass	0.66	tree providing heavy shade	0.25																																										
dark gray drapery closed	0.58	outside dark canvas awning	0.15																																										
tree providing light shade	0.55	outside adjustable louvers	0.15																																										
<i>Financial data: investment, operation and maintenance</i>	<p>The typical cost is proposed in the following table.</p> <p>Table 7. Typical costs for shading systems.</p> <table border="1"> <thead> <tr> <th>Type</th> <th>€/m<sup>2</sup></th> </tr> </thead> <tbody> <tr> <td>venetian, aluminium, manual, 94 mm</td> <td>217</td> </tr> <tr> <td>venetian, aluminium, motorized, 94 mm</td> <td>367</td> </tr> <tr> <td>directable blades 50mm aluminium, motorized</td> <td>969</td> </tr> <tr> <td>sliding aluminium frame, wooden fixed blades, 50 mm</td> <td>806</td> </tr> <tr> <td>directable blades 120mm on fixed frame</td> <td>328</td> </tr> <tr> <td>directable blades 120mm on fixed frame, motorized</td> <td>328</td> </tr> <tr> <td>fixed blades 50mm on fixed frame</td> <td>272</td> </tr> </tbody> </table> <p>Costs with VAT (22%) included, installation costs not included. Maintenance costs will depend on the frame material used. Expected lifetime is up to 30 years.</p>	Type	€/m <sup>2</sup>	venetian, aluminium, manual, 94 mm	217	venetian, aluminium, motorized, 94 mm	367	directable blades 50mm aluminium, motorized	969	sliding aluminium frame, wooden fixed blades, 50 mm	806	directable blades 120mm on fixed frame	328	directable blades 120mm on fixed frame, motorized	328	fixed blades 50mm on fixed frame	272																												
Type	€/m <sup>2</sup>																																												
venetian, aluminium, manual, 94 mm	217																																												
venetian, aluminium, motorized, 94 mm	367																																												
directable blades 50mm aluminium, motorized	969																																												
sliding aluminium frame, wooden fixed blades, 50 mm	806																																												
directable blades 120mm on fixed frame	328																																												
directable blades 120mm on fixed frame, motorized	328																																												
fixed blades 50mm on fixed frame	272																																												
<i>Environmental issues</i>	Many shading systems are made of glass and aluminium. Two materials produced by energy intensive processes contributing to adverse effects on climate. Effects can be reduced significantly by using recycled metals in production and ensuring a design in which glass panes and aluminium profiles can be reused or recycled at the end of the service life.																																												

<i>Development potential</i>	One area of development can be that of dynamic systems with performance optimization depending on the position of the sun.
<i>References</i>	[1] Solar shading for low energy buildings, European Solar Shading Organization, Meise, Belgium, 2012

### 3.1.5. Building automation control systems (BACS)/Energy monitoring systems (EMS)

Building automation control systems (BACS)/Energy monitoring systems (EMS)	
<p><i>Description</i></p>	<p>The primary function of these systems is to allow control and monitoring of energy streams. The primary challenge of using such systems on a district level is to allow for collective energy saving and demand side management (DSM).</p> <p>Building Automation Systems (BACS) generally refers to the data acquisition and control systems used to command main functions of buildings or groups of buildings such as heating, cooling, ventilation, air-conditioning, artificial lighting and solar blinds (EN 15232). Automation functions can be installed, for example for temperature control, indoor air quality control, lighting levels, settings of drivers and motors, monitoring and alarms for power management, diagnostic information, central operation and settings, and remote controls. In conjunction with energy management and monitoring systems (EMS), BACS allows for optimized tuning of energy functions and real time adaptation to environmental conditions, maximizing the use of renewables in a building or group of buildings. It also allows for continued optimizations during the operation phase.</p> <p>Energy Monitoring Systems (EMS) are currently mainly used to increase awareness and to provide access to or steer control systems. If the system only provides insights we speak of an Energy Monitoring System. If the system allows control, we identify it as Energy Management System. For residences, these systems are also identified as Home Energy Monitoring Systems (HEMS).</p> <p>When implemented on a district scale, EMS could lead to opportunities such as benchmarking of energy use and supporting energy flexibility at the district level.</p> <div data-bbox="475 1377 1406 1619" data-label="Image"> </div> <p>Figure 10. Example of a HEMS (Source: <a href="#">Triple-A</a>).</p>
<p><i>Main characteristics</i></p>	<p>Different manufacturers exist and the functionalities can widely differ. Existing EMS can digitize energy data, visualize energy data, collect and transfer energy data and analyse data for feedback purposes. Furthermore, some systems can use energy data to apply direct control (set point fixed or dynamic) to steer energy use for heating, energy use of equipment (on/off settings) or to apply rule-based control. EMS are a prerequisite to be able to collect and analyse energy data based on building, installation and use characteristics (Mlecnik &amp; M'Founougoulie, 2018).</p>

	<p>For energy flexibility purposes, advanced EMS are recommended that include tracking energy consumption and the energy the buildings produce, use and/or deliver back to the grid via renewable energy sources like PV-panels (IEA EBC Annex 67, 2019).</p>
<i>Power range</i>	N/A
<i>Technology interdependencies</i>	<p>BACS allow synergies with PV and Thermal Solar systems, as well as district heating and cooling systems and heat pumps.</p> <p>(H)EMS are being developed to act interdependent with other technologies such as smart meters, ICT, HVAC and solar control systems and (household) equipment. BACS and (H)EMS are critical components to achieve energy flexible buildings.</p>
<i>Advantages and disadvantages</i>	<p>The implementation of BACS needs a relatively high investment compared to EMS. BACS and EMS are currently mainly being adopted in non-residential buildings. It remains a challenge to diffuse HEMS in residential areas.</p> <p>To achieve district implementation there is a need for a new generation of cloud-based energy demand-response control systems, underpinned by semantic data models, and capable of adapting to near real-time environmental conditions while maximising the use of renewables and minimising energy demand within a district environment (Reynolds et al., 2017).</p>
<i>Typical energy savings for EMS solutions</i>	<p>In order to make optimal use of the energy saving potential of EMS it is important to understand the relationships between feedback measures, demand response measures and energy efficiency programs. Research finds that following interaction from feedback measures, setting individual energy-saving targets by the consumers themselves have the potential to yield the best results (Meijer et al., 2018). Research by Murray et al. (2015) also indicates that households and the individual appliances they use have distinct energy consumption patterns, and thus a personalized feedback approach is needed.</p> <p>Potential energy savings due to EMS targeting behaviour vary according to the feedback received (European Environment Agency, 2013):</p> <ul style="list-style-type: none"> <li>• Direct feedback (including smart meters): 5–15%</li> <li>• Indirect feedback (e.g. enhanced billing): 2–10%</li> <li>• Feedback and target setting: 5–15%</li> <li>• Energy audits: 5–20%</li> <li>• Community-based initiatives: 5–20%</li> <li>• Combination interventions (of more than one): 5–20%</li> </ul> <p>ACEEE (Ehrhardt-Martinez et al., 2010) found that - based on 36 studies carried out between 1995-2010 in countries all over the world - feedback with smart metering led to an average reduction between 3.8% and 12.0% in electricity consumption. Initiatives or pilots where real-time feedback was given appeared to have the largest effect on the energy savings, while enhanced billing feedback lead to systematically lower savings.</p>

<p><i>Energy performance of BACS</i></p>	<p>Using classes in BACS can allow characterizing the system regarding “improved efficiencies”. Departing from the classes defined in the EN 15232:2012 standard, such an approach can be found in the literature for residential buildings (Ippolito et al., 2014).</p> <p>Table 8. Typical efficiencies for BACS systems.</p> <table border="1" data-bbox="470 488 1428 745"> <thead> <tr> <th colspan="5">BACS efficiency factors for thermal and electric energy for residential buildings (EN 15232).</th> </tr> <tr> <th>Single family houses, apartment block and other residential buildings</th> <th>A</th> <th>B</th> <th>C</th> <th>D</th> </tr> </thead> <tbody> <tr> <td>Thermal energy BAC efficiency factor <math>f_{BAC,hc}</math></td> <td>0.81</td> <td>0.88</td> <td>1.00</td> <td>1.10</td> </tr> <tr> <td>Electric energy BAC efficiency factor <math>f_{BAC,e}</math></td> <td>0.92</td> <td>0.93</td> <td>1.00</td> <td>1.08</td> </tr> </tbody> </table> <p>Class A: High-energy performance BACS systems; • Class B: Advanced BACS systems; • Class C: Standard BACS; • Class D: Non-energy efficient BACS.</p>	BACS efficiency factors for thermal and electric energy for residential buildings (EN 15232).					Single family houses, apartment block and other residential buildings	A	B	C	D	Thermal energy BAC efficiency factor $f_{BAC,hc}$	0.81	0.88	1.00	1.10	Electric energy BAC efficiency factor $f_{BAC,e}$	0.92	0.93	1.00	1.08
BACS efficiency factors for thermal and electric energy for residential buildings (EN 15232).																					
Single family houses, apartment block and other residential buildings	A	B	C	D																	
Thermal energy BAC efficiency factor $f_{BAC,hc}$	0.81	0.88	1.00	1.10																	
Electric energy BAC efficiency factor $f_{BAC,e}$	0.92	0.93	1.00	1.08																	
<p><i>Financial data: investment, operation and maintenance</i></p>	<p>BACS: Factors determining the price of BACS include size and type of building, as well as which services are integrated in the system.</p> <p>EMS:</p> <p>The price of electricity metering devices is mainly dependent on their communication protocol, ease of deployment and automatic meter reading (AMR) compatibilities and ranges between \$300–700 (Ahmad et al., 2016).</p> <p>The cost of gas meters depends mainly on the measuring technology, pulse output option, AMR compatibility and measuring range and ranges between \$125-2600 (Ahmad et al., 2016). Generally, static methods-based meters are more expensive than dynamic ones.</p> <p>If applicable, one has to add costs for sensors (investment &amp; regular calibration) for measuring air temperature, air humidity, mean radiant temperature, air velocity, CO<sub>2</sub>, carbon monoxide (CO) and/or volatile organic compound (VOC) concentrations, occupancy and daylight, as well as supporting IT systems and Wi-Fi and electricity or battery connections. Wired systems can be more costly, but also more reliable. Sensors are becoming gradually cheaper and smaller.</p>																				
<p><i>Environmental issues</i></p>	<p>Wireless systems can save in cabling materials, but also can have a higher power consumption.</p>																				
<p><i>Development potential</i></p>	<p>The growing popularity of time of use tariffs and smart, Internet of Things (IoT) connected devices offer opportunities for Energy Service Companies to provide energy management and cost savings for adaptable users, while meeting energy and CO<sub>2</sub> reduction targets (Reynolds et al., 2017).</p>																				

	<p>The adoption of (H)EMS can coincide with the rollout of smart meters and energy bookkeeping systems as a precondition to give energy users feedback about actual energy consumption and to encourage users to lower their consumption (Meijer et al., 2018).</p>
<p><i>References</i></p>	<p>[1] Ahmad, M.W., Mourshed, M., Mundow, D., Sisinni, M., Rezgui, Y., 2016, Building energy metering and environmental monitoring – A state-of-the-art review and directions for future research, <i>Energy and Buildings</i> 120, 85-102, <a href="https://doi.org/10.1016/j.enbuild.2016.03.059">https://doi.org/10.1016/j.enbuild.2016.03.059</a></p> <p>[2] Ehrhardt-Martinez, K., Donely, K.A., Laitner, J.A., 2010, Advanced Metering Initiatives and Residential Feedback Programmes: A Meta-Review for Household Electricity-Saving Opportunities. American Council for an Energy-Efficient Economy (ACEEE).</p> <p>[3] EN 15232:2012 Standard: Energy Performance of Buildings – Impact of Building Automation, Controls, and Building Management"</p> <p>[4] European Environment Agency, 2013, Achieving energy efficiency through behaviour change: what does it take? EEA Technical report, No 5/2013.</p> <p>[5] IEA EBC Annex 67, 2019, Energy Flexible Buildings, <a href="http://annex67.org/">http://annex67.org/</a></p> <p>[6] Ippolito, M.G., Riva Sanseverino, E., Zizzo, G., 2014, Impact of building automation control systems and technical building management systems on the energy performance class of residential buildings: An Italian case study, <i>Energy and Buildings</i>, 69, 33-40, <a href="https://doi.org/10.1016/j.enbuild.2013.10.025">https://doi.org/10.1016/j.enbuild.2013.10.025</a></p> <p>[7] Meijer, F., Straub, A., Mlecnik, E., 2018, Impact of Home Energy Monitoring and Management Systems (HEMS), Triple-A: Stimulating the Adoption of low-carbon technologies by homeowners through increased Awareness and easy Access, D2.1.1. Report on impact of HEMS, <a href="http://www.triple-a-interreg.eu/project-reports">http://www.triple-a-interreg.eu/project-reports</a></p> <p>[8] Mlecnik, E., M'Founougoulie, K., 2018, Inventory HEMS, Working document Interreg 2 Seas Triple-A project (2016-2020).</p> <p>[9] Murray, D., Liao, J., Stankovic, L., Stankovic, V., Hauxwell-Baldwin, R., Wilson, C., Coleman, M., Kane, T., Firth, S., 2015, A data management platform for personalised real-time energy Feedback, Proceedings of the 8th International Conference on Energy Efficiency in Domestic Appliances and Lighting, 26-28 August, Lucerne.</p> <p>[10] Reynolds, J., Rezgui, Y., Hippolyte, J.L., 2017, Upscaling energy control from building to districts: Current limitations and future perspectives, <i>Sustainable Cities and Society</i> 35, 816-829, <a href="https://doi.org/10.1016/j.scs.2017.05.012">https://doi.org/10.1016/j.scs.2017.05.012</a></p>

## 3.2. Energy distribution and supply systems

### 3.2.1. Low-temperature thermal grids

Low-temperature thermal grids	
<i>Description</i>	<p><i>Definition</i></p> <p>Low-temperature thermal grids (LTTG) are not well-defined. Some consider low-temperature district heating networks as LTTG and others consider them cold district heating – see the description of these below.</p> <p><i>Low-temperature district heating</i></p> <p>Low temperature district heating systems operate at such a temperature that it still enables the customer to guarantee the minimum necessary domestic hot water temperature, just at the point of use, in accordance with hygiene regulations and comfort requirements. With these concepts, this results in flow temperatures between 50-70°C and target temperatures of 20-40°C in the return flow. These temperatures lead to reduced heat network losses, easier feed-in of low temperature waste heat, solar thermal energy and ambient heat through large heat pumps as well as efficient operation of (decentralised) combined heat and power (CHP) systems and large heat storage tanks. In addition to the classification shown here, the literature contains various terms with differing or not always clearly defined very low temperature (VLT) levels, e.g. LowEx networks (45-60°C), or 4th Generation district heating (DH) networks (35-60°C).</p> <p><i>Cold district heating / energy networks</i></p> <p>With cold district heating, the basic idea is to use low-energy heat sources such as low temperature (LT) waste heat, geothermal energy, surface water, groundwater, waste water, LT solar thermal energy (e.g. inexpensive uncovered plastic collectors, PVT collectors) and flue gas condensation by means of velocity control (VLT) levels (&lt;35°C) in order to almost completely eliminate transport losses. The supply temperature of these networks is below the minimum temperature required for hygienic drinking water supply and in some cases also below the minimum temperature required for room heating supply, so that decentralised heat pumps ("booster units") ensure a corresponding increase in temperature for the customers. The use of waste heat sources have so far hardly been tapped. The avoidance of transport losses and the use of renewable LT heat sources and heat pumps that can be operated with high efficiency due to the high source temperature have significant advantages. With these solutions, a significant reduction in the primary energy input is expected compared to conventional district heating or decentralised solutions without a heating network, although this is controversial among experts, as no reliable assessment methods and analyses are yet available.</p>



Cold district heating refers to heating networks operated in a temperature range of  $<35^{\circ}\text{C}$  and thus close to the ambient temperature. These are also referred to as ultra-low temperature district heating networks or 5th generation heating networks.

Since the system temperatures are hardly higher than the ambient temperature, insulated district heating pipelines can be dispensed with and much more cost-effective plastic pipelines (analogous to drinking water supply) can be used. In recent years, the first isolated demonstration projects for cold district heating have been implemented. For example, Stadtwerke München uses groundwater from the drainage system of underground tunnels as a heat source to supply individual large customers via a cold district heating pipe and heat pumps on the customer's side. There are other comparable applications with low system temperatures such as waste heat recovery from waste water (often used in Switzerland, but also in Amstetten (AT)) or aquifer storage systems in combination with heat pumps (ATES) in the Netherlands, where building networks are supplied with heat and cooling at a maximum temperature level from  $25^{\circ}\text{C}$ . Further applications with very different and partly special system configurations were implemented in Wüstenrot, March-Hugstetten, Craisheim, Büsingen or Dollnstein (all DE).

Local district heating/cooling solutions in combination with small and large heat pumps is based on a local district heating network for a group of buildings or a small district that has a significantly lower temperature than the regular district heating network. Such a local network can be connected to the larger network, and can draw energy from this whenever needed.

The local network supplies water at a temperature of  $20^{\circ}\text{C}$  (compared to the  $70^{\circ}\text{C}$  of a typical district heating network).

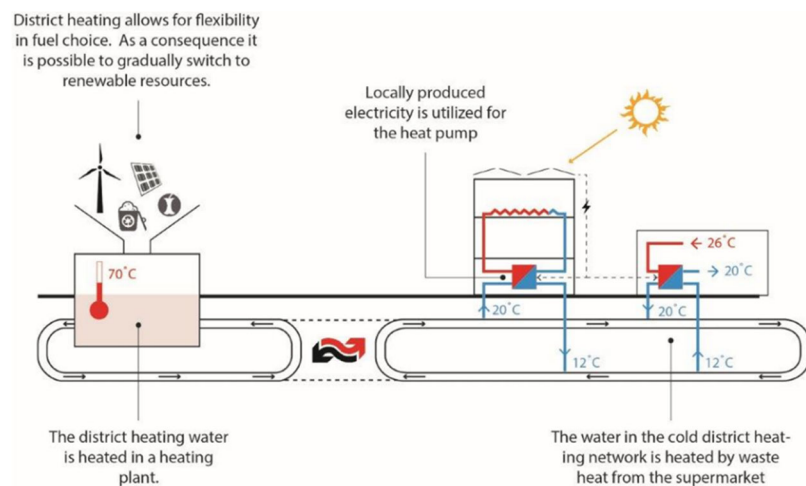
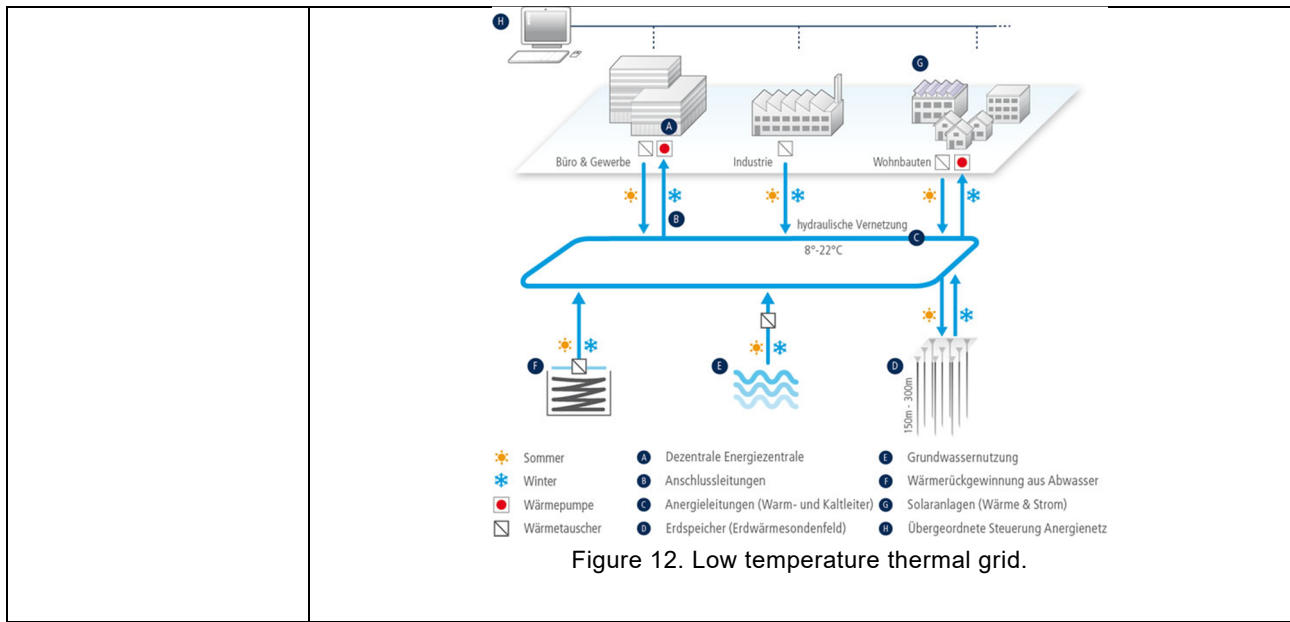
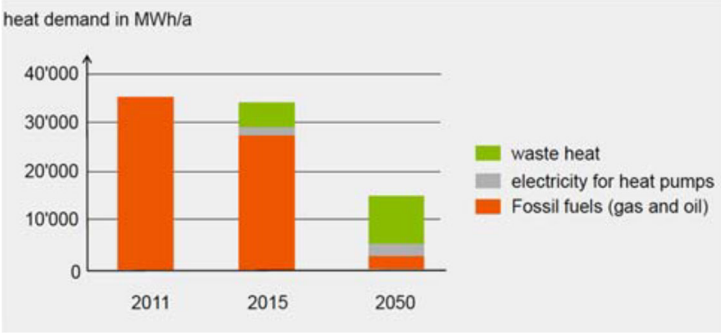

Figure 11. Schematic of the interconnection between local and global district heating system.



<i>Main characteristics</i>	Heating and cooling supply and distribution system at district level
<i>Power range</i>	Not directly applicable – see energy performance data.
<i>Technology interdependencies</i>	<p>LTTG may include and be in synergy with:</p> <ul style="list-style-type: none"> <li>• high energy performance buildings</li> <li>• low temperature heating</li> <li>• high temperature cooling</li> <li>• integration of local or distributed renewable energy sources, e.g. PV and solar thermal</li> <li>• some heat consumers may also become heat producers</li> <li>• use of cogeneration</li> <li>• cascade usage to enable maximum exploitation of available energy resources</li> <li>• shift from the demand driven network to a combination of demand and supply driven network</li> <li>• heat storage, could be: borehole thermal energy storage (BTES) and aquifer thermal energy storage (ATES), combined with decentral storage technologies at building level (Thermally activated buildings, compact and water storage)</li> <li>• multiple temperature levels, district heating &amp; district cooling</li> </ul>
<i>Advantages and disadvantages</i>	<p><b>Advantages Low Temperature District Heating</b></p> <ul style="list-style-type: none"> <li>• lower system temperatures lead to lower losses and primary energy demand</li> </ul> <p><b>Disadvantages Low Temperature District Heating</b></p> <ul style="list-style-type: none"> <li>• no cooling supply</li> </ul> <p><b>Advantages Cold District Heating and Cooling</b></p> <ul style="list-style-type: none"> <li>• combined heating and cooling supply</li> <li>• use of low-exergy sources (solar thermal, surface water, waste heat)</li> <li>• flexible and expendable system structure, combination with heat pumps allows for sector coupling</li> <li>• limited distribution losses</li> </ul> <p><b>Disadvantages Cold District Heating and Cooling</b></p> <ul style="list-style-type: none"> <li>• partly complex structure</li> <li>• needs low-exergy source (not always present)</li> </ul>

<p><i>Typical energy data and prices for LTTG+ solutions for one country</i></p>	<p>One example from Switzerland: The Friesenberg (Familienheim-Genossenschaft) network will supply 2.300 apartments and houses (5.700 inhabitants) with 35.000 MWh for heating and 80.000 MWh for cooling [2].</p>																
<p><i>Energy performance</i></p>	<p>The use of LTTG may result in increased efficiencies for heat pumps for heating or cooling and for thermal solar systems allowing for considerable fossil fuel reductions.</p>  <table border="1" data-bbox="469 528 1193 860"> <caption>Estimated data for Figure 13: Heat demand in MWh/a</caption> <thead> <tr> <th>Year</th> <th>Fossil fuels (gas and oil)</th> <th>Electricity for heat pumps</th> <th>Waste heat</th> </tr> </thead> <tbody> <tr> <td>2011</td> <td>35,000</td> <td>0</td> <td>0</td> </tr> <tr> <td>2015</td> <td>28,000</td> <td>2,000</td> <td>4,000</td> </tr> <tr> <td>2050</td> <td>3,000</td> <td>2,000</td> <td>10,000</td> </tr> </tbody> </table> <p>Figure 13. Energy mix for Friesenberg network in Zürich before and after implementing the LTTG [2].</p>	Year	Fossil fuels (gas and oil)	Electricity for heat pumps	Waste heat	2011	35,000	0	0	2015	28,000	2,000	4,000	2050	3,000	2,000	10,000
Year	Fossil fuels (gas and oil)	Electricity for heat pumps	Waste heat														
2011	35,000	0	0														
2015	28,000	2,000	4,000														
2050	3,000	2,000	10,000														
<p><i>Financial data: investment, operation and maintenance</i></p>	<p>Case-dependent</p>																
<p><i>Environmental issues</i></p>	<p>-</p>																
<p><i>Development potential</i></p>	<p>The technology itself is known, but not very widely used. Increased use will result in valuable experiences and from that improved performance.</p>																
<p><i>References</i></p>	<p>[1] <a href="http://www.degruyter.com/downloadpdf/j/sbeef.ahead-of-print/sbeef-2016-0030/sbeef-2016-0030.pdf">www.degruyter.com/downloadpdf/j/sbeef.ahead-of-print/sbeef-2016-0030/sbeef-2016-0030.pdf</a></p> <p>[2] Matthias Kolb - Operational Experience with Low Temperature Networks in Zurich, Switzerland (presentation in Geneva, 30.10.2015):</p> <p>[3] <a href="http://iea-gia.org/wp-content/uploads/2016/05/1-11-Link-Smart-Geothermal-Applications-%E2%80%93-Switzerland.pdf">iea-gia.org/wp-content/uploads/2016/05/1-11-Link-Smart-Geothermal-Applications-%E2%80%93-Switzerland.pdf</a></p> <p>[4] Sommer, W., 2015. Modelling and monitoring Aquifer Thermal Energy Storage, Wageningen University, Niederlande</p> <p>[5] C.A.R.M.E.N. e.V., <a href="https://www.carmen-ev.de/biogene-festbrennstoffe/waermetetze/1966-waermetetze-neu-gedacht">https://www.carmen-ev.de/biogene-festbrennstoffe/waermetetze/1966-waermetetze-neu-gedacht</a> (abgerufen 09.2017)</p>																

### 3.2.2. Cogeneration

<b>Cogeneration</b>	
<i>Description</i>	<p>Cogeneration (Combined Heat and Power or CHP) is the simultaneous production of electricity and heat, both of which are used. Cogeneration can offer energy savings ranging between 15-40% when compared against the supply of electricity and heat from conventional power stations and boilers. Moreover, the cogeneration can optimize the energy supply to all types of consumers, with some benefits for both users and society at large by increasing the efficiency of energy conversion and use and lowering the emissions to the environment, in particular of CO<sub>2</sub>. It also has the potential to save cost, providing additional competitiveness for industrial and commercial users, and offering affordable heat for domestic users.</p> <p>The cogeneration is an opportunity to move towards more decentralised forms of electricity generation, where plants are designed to meet the needs of local consumers, providing high efficiency, avoiding transmission losses and increasing flexibility of system use. Below equipment and systems for energy production is described.</p> <p><b>Internal Combustion Engines</b></p> <p>The cogeneration using internal combustion engines operates mainly according to the Otto cycle and the Diesel cycle. Being the heat source "internal" to the machine, the choice of fuels shall be environmentally compatible; the main fuels are petrol, natural gas or biofuel for the Otto engine and diesel and bio-diesel for the Diesel engine. The crankshaft connected to an alternator produces electricity and at the same time heat recovery can be realized in four points:</p> <ul style="list-style-type: none"><li>• from the exhaust fumes: at the exit from the engine, these fumes can reach 400-500°C and can be cooled to about 200°C. It is possible to recover between 30% and 35% of the heat supplied to the engine;</li><li>• from cooling water it is possible to recover 25% of the heat supplied to the engine and the recovery thermal level is around 85-90°C;</li><li>• from lubricating oil, overall it is possible to recover 4-7% of the heat supplied to the engine and the recovery thermal level is around 85-90°C;</li><li>• from the air: if there is a supercharging system, a part of the heat can also be recovered from the combustion air injection device.</li></ul> <p>In order for the efficiency of the motor to remain high, it is preferable to operate in continuous mode, satisfying the maximum demand for electrical production and disposing of excess heat. To satisfy the thermal demand peaks, the system must be integrated with auxiliary boilers and accumulation systems.</p>

With these systems, it is also possible to cover a wide range of power between 1kW and 20MW. In the last ten years, some engines of very small size have been proposed on the market suitable for domestic cogeneration (1-5kWe). For micro-cogeneration units, small automotive engines have successfully been used.

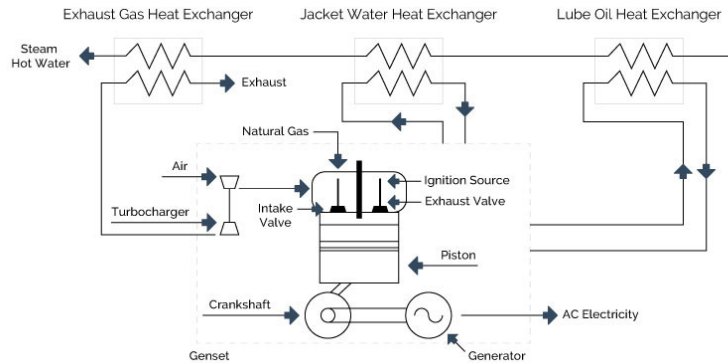

Figure 14. Schematic representation of internal combustion engine cogeneration system.

The simplest packaged and modular CHP (Combined Heat and Power) systems are found in tightly integrated systems in general categories such as the following for reciprocating engine systems:

- Small engine generators (under 500kW) recover jacket and exhaust heat in the form of hot water. Packaged systems include electronic safety and interconnection equipment.
- Small packaged and split-system engine heat pumps, integrating engines with complete vapour compression heat pumps and engine jacket and exhaust heat recovery, available under 175kW.
- Engine packaged systems (typically 100-2000kW) can drive generators, compressors, or pumps. Engine/generators recover at least jacket heat, and several modular systems integrate jacket water and exhaust systems to directly power single- and two-stage absorption chillers, providing power, heating, and cooling.

### Organic Rankine Cycle

The principle of the Organic Rankine Cycle (ORC) technology was established as early as 1826 by T. Howard who first experimented the use of ether as working fluid in a power cycle.

ORC technologies are increasingly of interest for cost-effective sustainable energy generation. Popular applications include cogeneration from biomass and electricity generation from geothermal reservoirs and concentrating solar power installations, as well as waste heat recovery from gas turbines, internal combustion engines and medium- and

low-temperature industrial processes. There are hundreds of ORC power systems already in operation and the market is growing at a fast pace.

Power generation from geothermal brines is the main field of application with 74.8% of all ORC installed capacity in the world.

The Rankine Cycle is a thermodynamic cycle that converts heat into work. The heat is supplied to a closed loop, which typically uses water as working fluid. The Rankine Cycle based on water provides approximately 85% of worldwide electricity production. ORC is basically a cycle with a steam turbine that uses a high molecular mass organic fluid instead of water.

The layout of the ORC is somewhat simpler than that of the steam Rankine cycle: there is no water–steam drum connected to the boiler, and one single heat exchanger can be used to perform the three evaporation phases: preheating, vaporization and superheating. The variations of the cycle architecture are also more limited: reheating and turbine bleeding are generally not suitable for the ORC cycle, but a recuperator can be installed as liquid preheater between the pump outlet and the expander outlet. This allows reducing the amount of heat needed to vaporize the fluid in the evaporator.

The possibility to select the best working fluid depending on the available heat source and the plant size, results in multiple advantages: (i) more efficient turbomachinery, (ii) limited vacuum at condenser and (iii) higher performance compared to both steam Rankine cycles and gas cycles especially for heat sources lower than 400°C and power output lower than 20MW.

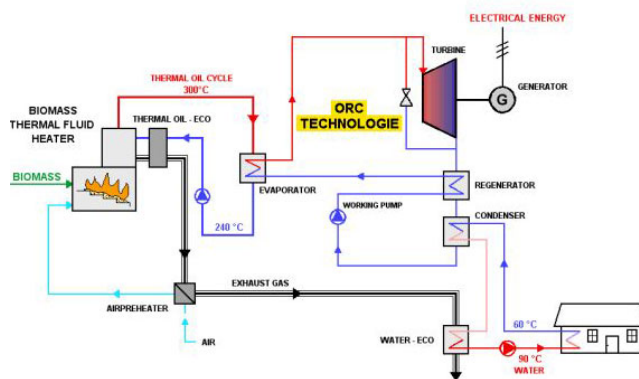

Figure 15. Schematic representation of biomass cogeneration with ORC technology.

<i>Main characteristics</i>	Production of heat and electric power
<i>Power range</i>	From few kW to MW of electric power

*Technology interdependencies*

Synergies with solar thermal, absorption cooling, storage systems and district heating and cooling systems.

**Biomasses Application**

Heat from the combustion is transferred from the flue gases to the heat transfer fluid (thermal oil) in two heat exchangers, at a temperature varying between 150-320°C. The heat transfer fluid is then directed to the ORC loop to evaporate the working fluid, at a temperatures lightly lower than 300°C. Next, the evaporated fluid is expanded, passes through a recovery heat exchanger to preheat the liquid and is finally condensed at a temperature around 90°C. The condenser is used for hot water generation. Although the electrical efficiency of the CHP system is limited (18%), the overall efficiency of the system is 88%, which is much higher than that of centralized power plants, in which most of the residual heat is lost.

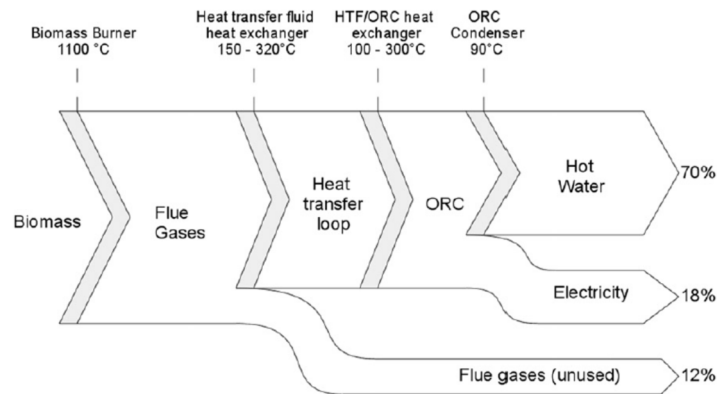

Figure 16. Energy flow as a function of the conversion temperatures in a CHP ORC system.

**Geothermal**

Geothermal heat sources are available over a broad range of temperatures, from a few tens of degrees up to 300°C. The actual technological lower bound for power generation is about 80°C: below this temperature the conversion efficiency becomes too small and geothermal plants are not economical.

Low-temperature geothermal ORC plants are also characterized by relatively high auxiliary consumption: the pumps consume from 30% to more than 50% of the gross output power. The main consumer is the brine pump that has to circulate the brine over large distances and with a significantly high flow rate. The working fluid pump consumption is also higher than in higher temperature cycles, because the ratio between pump consumption and turbine output power (“back work ratio”) increases with decreasing evaporation temperature. Higher temperature (>150°C) geothermal heat sources enable combined heat and power generation: the condensing temperature is set to a higher level (e.g.60 °C), allowing the cooling water to be used for district heating. In this case, the overall energy recovery efficiency is increased, but at the expense of a lower electrical efficiency.

	<p><b>Waste heat recovery</b></p> <p>Many applications in the manufacturing industry reject heat at relatively low temperature. In large-scale plants, this heat is usually overabundant and often cannot be reintegrated entirely on-site or used for district heating. It is therefore rejected to the atmosphere.</p> <p>Recovering waste heat mitigates the pollution. It can moreover generate electricity to be consumed on-site or fed back to the grid. In such a system, the waste heat is usually recovered by an intermediate heat transfer loop and used to evaporate the working fluid of the ORC cycle. A potential of 750MWe is estimated for power generation from industrial waste heat in the US, 500MWe in Germany and 3000MWe in Europe (EU-12).</p> <p><b>Solar power plant</b></p> <p>Concentrating solar power is a well-proven technology: the sun is tracked and its radiation reflected onto a linear or punctual collector, transferring heat to a fluid at high temperature. This heat is then used in a power cycle to generate electricity.</p> <p>Parabolic dishes and solar towers are punctual concentration technologies, leading to a higher concentration factor and to higher temperatures.</p> <p>The most appropriate power cycles for these technologies are the Stirling engine (for small-scale plants), the steam cycle, or even the combined cycle (for solar towers). Parabolic troughs work at a lower temperature (300–400°C) than point-focused CSP systems. Up to now, they were mainly coupled to traditional steam Rankine cycles for power generation. They are subject to the same limitations as in geothermal or biomass power plants: steam cycles require high temperatures, high pressures, and therefore larger installed power to be profitable.</p> <p>In CHP or solar applications, the cycle efficiency is usually maximized, while in WHR applications, the output power should be maximized. It follows that, since no working fluid can be flagged as optimal, the study of the working fluid candidates should be integrated into the design process of any ORC system.</p>
<p><i>Advantages and disadvantages</i></p>	<p>Advantages</p> <ul style="list-style-type: none"> <li>• great flexibility and reliability obtained by transferring the experience accumulated in the propulsion</li> <li>• modularity, realized by varying the number of cylinders according to the power to be supplied</li> <li>• high electrical yields even if different typologies or equipment for electricity production are used</li> <li>• easy start-up and reliability of the ignition system, together with the speed of set-up.</li> <li>• In the field of renewable fuels there are a multiplicity of applications: bio-gas, ethanol, bio-diesel, vegetable oils, oils deriving from processes industrial processing of organic substances, oils from animal fats, used cooking oils, etc.</li> </ul>



- improved local and general security of supply – local generation, through cogeneration, can reduce the risk of consumers being left without supplies of electricity and/or heating.
- the reduced need for fuel resulting from cogeneration reduces import dependency – helping to tackle a key challenge for Europe's energy future.

Disadvantages

- high maintenance costs for large-scale installations
- rather high emissions of all the major macro-pollutants of regulatory interest

Concerning ORC in particular, maintenance can be problematic even if it is a mature technology. Solar applications are negligible mainly because of the high investment cost of the solar field that makes ORC coupled with concentrating collectors more expensive than photovoltaic panels and battery systems.

*Typical energy data and prices for CHP solutions for one country*

Table 9. Main thermodynamic characteristics of wood-fuelled CHP plants in the power range of 100 kW<sub>e</sub>

characteristic	Gasification	RSE	ORC	SE	EFMGT
Specific biomass consumption (humidity 40 %), kg/kWh <sub>e</sub>	1.2-1.7	4-5	2.5-3.5	3.5-4	2.5-3.5
EE, %	~ 25	~ 8	~ 12	~10	~12
TE, %	~ 25	~ 75	~ 70	~ 60	~ 40
Heat temperature available, °C	80-500	100-150	30-80	60-85	40-80
Operation time, h/y	7000	7000-8000	8000	7000	7000-8000
Specific Cost, €/kW <sub>e</sub>	3000-5000	5000-6000	5000-7000	6000-8000	6000-7000

RSE = Reciprocating Steam Engine;  
 ORC = Organic Rankine Cycle;  
 SE = Stirling Engine;  
 EFMGT = Externally Fired Micro Gas Turbine;  
 EE = Electrical efficiency;  
 TE = Thermal efficiency

ORC manufacturers have been present on the market since the beginning of the 1980s. They provide ORC solutions in a broad range of power and temperature levels. The three main manufacturers in terms of installed units and installed power are Turboden (Pratt & Whitney) (45% of installed units worldwide, 8.6% of cumulated power), ORMAT (24% of installed units, 86% of cumulated power) and Maxxtec (23% of installed units, 3.4% of cumulated power).

Table 10 shows the main characteristics and technologies as proposed by the main manufacturers.

Table 10. ORC manufacturers, power and heat source ranges and technologies

Manufacturer	Applications	Power range [kW <sub>e</sub> ]	Heat source temperature [°C]	Technology
ORMAT, US	Geo., WHR, solar	200-70,000	150-300	Fluid : n-pentane and others, two-stage axial turbine, synchronous generator
Turboden, Italy	Biomass-CHP, WHR, Geo.	200-2000	100-300	Fluids : OMTS, Solkatherm, Two-stage axial turbines
Adoratec/Maxxtec, Germany	Biomass-CHP	315-1600	300	Fluid: OMTS
Opcon, Sweden	WHR	350-800	< 120	Fluid: Ammonia, Lysholm Turbine
GMK, Germany	WHR, Geo., Biomass-CHP	50-5000	120-350	3000 rpm Multi-stage axial turbines (KKK)
Bosch KWK, Germany	WHR	65-325	120-150	Fluid: R245fa
Turboden PureCycle, US	WHR, Geo.	280	91-149	Radial inflow turbine, Fluid: R245fa
GE CleanCycle	WHR	125	> 121	Single-state radial inflow turbine, 30,000 rpm, Fluid: R2
Cryostar, France	WHR, Geo.	n/a	100-400	Radial inflow turbine, Fluids: R245fa, R134a
Tri-o-gen, Netherlands	WHR	160	> 350	Radial turbo-expander, Fluid: Toluene
Electrathem, US	WHR, Solar	50	> 93	Twin screw expander, Fluid: R245fa

<p><i>Energy performance</i></p>	<p>The net electric efficiency <math>\eta_E</math> of a generator can be defined by the first law of thermodynamics as net electrical energy output <math>W_E</math> divided by fuel input <math>Q_{fuel}</math> in terms of kilowatt-hours of thermal energy content:</p> $\eta_E = \frac{W_E}{Q_{fuel}}$ <p>A CHP system, by definition, produces useful thermal energy (heat) as well as electricity. If the first law is applied, adding the useful thermal energy <math>Q_{TH}</math>, converted from MJ to kWh, to the net electrical output and dividing by the fuel consumed (which is how virtually all CHP system efficiencies are reported), the result is the overall CHP system efficiency <math>\eta_O</math>, which does not account for the relative useful work potential of the two different energy streams:</p> $\eta_O = \frac{W_E + \sum Q_{TH}}{Q_{fuel}}$ <p>For CHP systems delivering electric and thermal power (in the form of steam and/or hot water, or direct heating), the CHP electric effectiveness <math>\varepsilon_{EE}</math> is defined as:</p> $\varepsilon_{EE} = \frac{W_E}{Q_{fuel} - \frac{\sum Q_{TH}}{\alpha}}$ <p>where <math>\alpha</math> is the efficiency of the conventional technology that otherwise would be used to provide the useful thermal energy output of the system (for steam or hot water, a conventional boiler).</p> <p>Full load electric efficiency of internal combustion engine (ICE) CHP units is from 25.9% to 45.6% for natural gas fired units and from 29.8% to 44.0% for biogas fired units.</p> <p>The overall efficiency for natural gas based units is between 77.0 and 98.8% and from 51.7 to 93.5% for biogas based units.</p> <p>The performance of recently developed prototypes of ORC cycles is promising: the system designed by Honda showed a maximum cycle thermal efficiency of 13%. At 100 km/h, this yields a cycle output of 2.5kW (for an engine output of 19.2kW) and represents an increase of the engine thermal efficiency from 28.9% to 32.7%.</p>
<p><i>Financial data: investment, operation and maintenance</i></p>	<p>Internal Combustion Engines</p> <p>CHP systems can offset capital costs that would otherwise be needed to purchase and install certain facility components, such as boiler and chiller systems in new construction. Installing CHP systems with backup capability can avoid the need for a local government to purchase a conventional backup electricity generator. A typical back-up diesel generator (with accompanying controls and switchgear) can cost as much as \$550 per kW, compared with \$100–\$250 per kW to add backup capability to a CHP system.</p>

### Organic Rankine Cycle

Comparing the available information about financial revenue from Turboden (2002 to 2010) and ORMAT (2012 to 2015) to their actual installed capacity over the same period gives an average ratio between \$1410/kW (ORMAT) and \$1580/kW (Turboden). Therefore, it is possible to estimate the total value of the ORC market to be between \$359 million and \$402 million per year in 2016. This includes only the sales of equipment and direct engineering services, excluding complementary revenues such as electricity or heat generation, exploration and subsurface engineering for geothermal projects. Small ORC units have a much higher cost per kW, but units less than 500kW do not represent more than 2% of the total installed capacity and can be neglected.

When comparing the technology and the costs of biomass CHP using an ORC with gasification, it can be shown that gasification involves higher investment costs (about 75%) and higher operation and maintenance costs (about 200%). On the other hand, gasification yields a higher power-to-thermal ratio, which makes its exploitation more profitable.

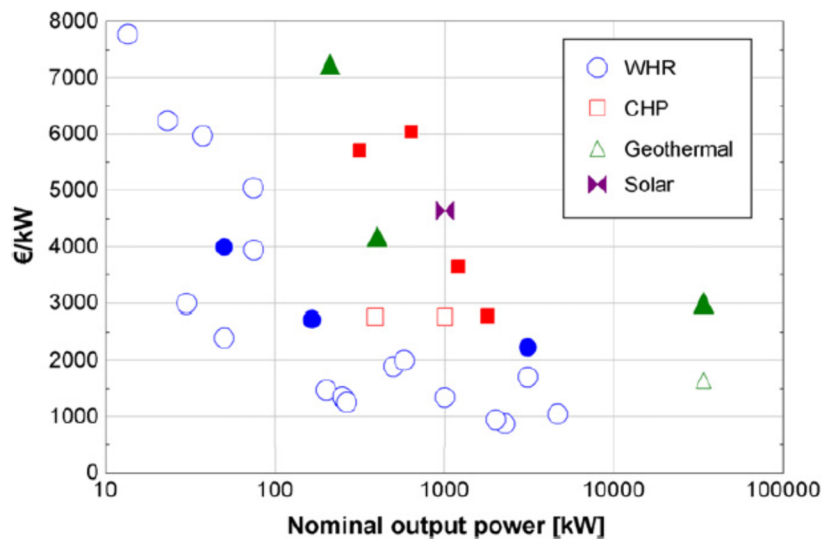

Figure 17. Module (empty dots) and total (plain dots) cost of ORC systems depending on the target application and on the net electrical power.

#### Environmental issues

Because CHP systems require less fuel to produce the same energy output as separate heat and power (SHP) systems, CHP systems can reduce emissions of GHGs and air pollutants, such as nitrogen oxides (NO<sub>x</sub>) and sulphur dioxide (SO<sub>2</sub>).

The Waste Heat Recover application allow to mitigate both the pollutants production (CO<sub>2</sub>, NO<sub>x</sub>, SO<sub>x</sub>, HC) present in the flue gases and the heat rejected.

Solar power application could help the development of rural areas.

Geothermal and biomasses application allow to decrease CO<sub>2</sub> production.

#### Development potential

Current R&D focuses mainly on ORC working fluid selection issues, but also on innovative cycle's architectures.

	<p>Some research groups focus on turbine optimization, which involves studying real-gas effects (in particular close to the critical point) and developing new accurate equations of states.</p> <p>Regarding the control strategies, state-of-the-art ORC units are usually designed for a nominal operating point, and exhibit poor performance in part-load conditions.</p>
<p><i>References</i></p>	<p>[1] doi.org/10.1080/15435075.2014.962032</p> <p>[2] doi.org/10.1051/e3sconf/20198501012</p> <p>[3] www.researchgate.net/publication/261021546</p> <p>[4] <a href="http://www.epa.gov/sites/production/files/.../chpguide508.pdf">www.epa.gov/sites/production/files/.../chpguide508.pdf</a></p> <p>[5] <a href="http://www.appa.org/files/PDFs/EDUCOGEN_Cogen_Guide.pdf">www.appa.org/files/PDFs/EDUCOGEN_Cogen_Guide.pdf</a></p> <p>[6] arpi.unipi.it/retrieve/handle/11568/434267/48239/Small-scale%20wood-fuelled%20CHP%20plants.pdf</p> <p>[7] dx.doi.org/10.1016/j.rser.2013.01.028</p> <p>[8] dx.doi.org/10.1016/j.csite.2015.09.003</p> <p>[9] 10.1016/j.egypro.2017.09.159</p> <p>[10] 10.1016/j.egypro.2017.09.160</p> <p>[11] <a href="http://www.turboden.eu/en/public/downloads/11-COM.P-18-rev.4_HR_ENG.pdf">www.turboden.eu/en/public/downloads/11-COM.P-18-rev.4_HR_ENG.pdf</a></p> <p>[12] investor.oramat.com/GenPage.aspx?IID=4087066&amp;GKP=302737</p> <p>[13] <a href="http://www.cogeneurope.eu">www.cogeneurope.eu</a></p>

### 3.2.3. Cooling

Cooling	
<i>Description</i>	<p>During periods characterized by warm weather or significant thermal gains (coming from solar radiation, people and electrical equipment) it can be necessary to provide cooling to buildings to guarantee the comfort air temperature and humidity.</p> <p>The market for space cooling equipment has a high growth rate, which is likely to be sustained beyond 2030 - especially in Europe where Italy, Spain, Greece and France together account for the majority of EU sales.</p> <p>Different strategies are available: on one hand mechanical equipment based on gas compression or adsorption cycles, on the other hand natural cooling based mainly on ventilation, earth heat exchange or evaporation.</p> <p>The typical cooling equipment used in HVAC systems is the <b>compression refrigerator</b> working on a thermodynamic cycle based on the compression and expansion of a circulating fluid. In a so-called reversing heat pump the refrigeration cycle can be changed from cooling to heating or vice versa.</p> <p>Hereby, it absorbs and removes heat from the space to be cooled and subsequently rejects that to a heat sink or vice versa. The heat sink can be the air, water or the ground. The lower the temperature of the sink, the higher efficiency of the machine during summer. The higher the temperature of the sink, the higher efficiency of the machine during winter. This also means that the ground, which maintains a stable temperature along the year and increase temperature with depth, is the better sink, followed by water from a lake or a river or the sea. In any case the system can also work with air. Coefficient of performance (COP) is a parameter used for evaluate the performance of these devices; it could be defined as the ratio between the heat flow removed from the space and the mechanical power requested by the compressor. COPs of compression chillers are high. The higher is obtained using water or ground as heat sink arriving around 5-6, usual values for air cooled are around 3-4.</p>

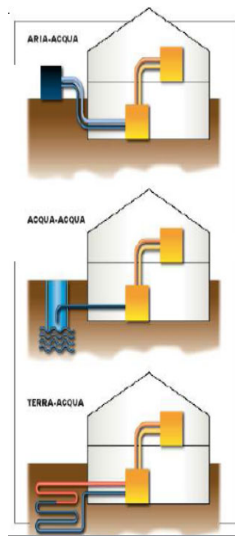

Figure 18. Different kind of heat sink for a refrigeration system.

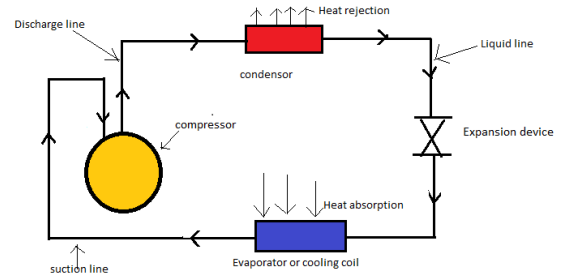

Figure 19. Scheme of a typical vapour compression thermodynamic cycle

An **absorption refrigerator** uses a heat source (e.g. solar energy, a fossil-fuelled flame, waste heat from factories, or district heating systems) to provide cooling. Usually it is used where waste heat is available or where heat is derived from [4]. Connected to a cogeneration system it can recover energy during the cooling period. Rather than a mechanical compressor like the ones used in compression refrigeration systems, absorption chillers operate on the basis of a so-called thermal compressor. Two widespread absorption cycles currently in use are the lithium bromide (LiBr) cycle and the ammonia-water ( $\text{NH}_3\text{H}_2\text{O}$ ) cycle. In the former, water acts as the refrigerant and LiBr as the absorbent. In the latter, the ammonia water solution is the refrigerant and water is the absorbent. The LiBr cycle tends to be more common.

For the absorption chillers, the coefficient of performance (COP) is defined as the heat ratio  $Q_{\text{cold}} / Q_{\text{hot}}$ , i.e. it is the cooling realized divided by the driving heat supplied (see Figure 20  $Q_{\text{cold}} = \Phi_E$  and  $Q_{\text{hot}} = \Phi_G$ ).

COPs of absorption chillers are low. Single effect LiBr machines offer COPs of 0.65 ~ 0.7 and double-effect chillers can achieve COPs of about 1.2. The temperature of the heat source is the most important factor in the thermal efficiency of an absorption chiller. The higher the temperature of the heat source, the better the COP.

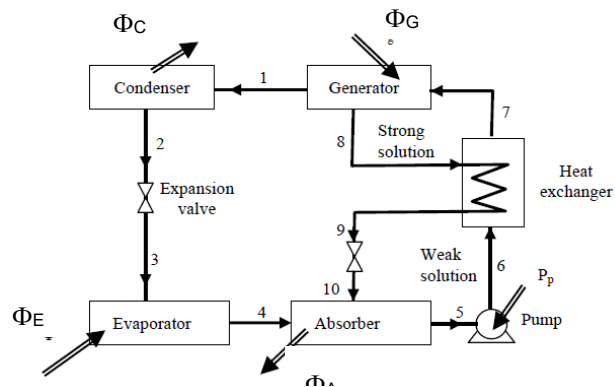

Figure 20. Schematic representation of adsorption cooling technology.

**Natural cooling** can save a lot of energy by decreasing or eliminating the need for mechanical cooling. It is typically based on the availability of a “natural” heat sink. The most important ones are the ground and the atmosphere.

It is possible to **heat exchange with the ground** using a buried channel that pre-cools or pre-heats the ventilation air. In fact, ground at 1-2 m depth maintains a constant temperature around the year corresponding to the mean air temperature.

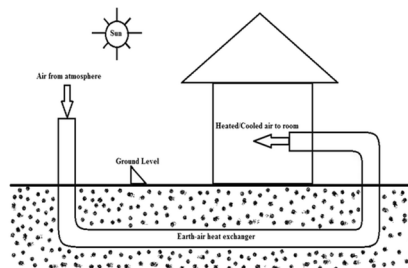

Figure 21. Scheme of precooling of air.

It is possible to use the **air** at low temperature especially during night to **free cool** the buildings. It is important to have sufficient mass in the structure as a storing agent.

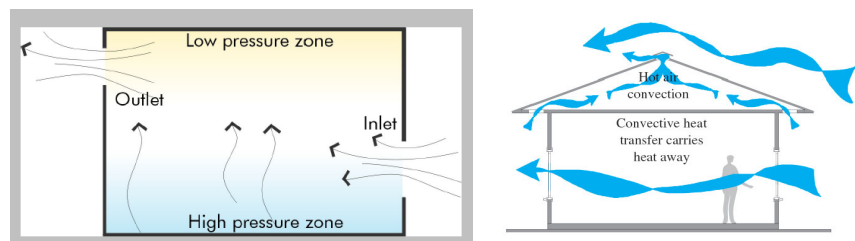

Figure 22. Scheme of convective cooling.

Moreover dry air can be cooled down significantly through the phase transition of liquid water to water vapour (evaporation) as water in fact absorbs a relatively large amount of heat in order to evaporate. This is called evaporative cooling, and it can be achieved by spraying

	water directly into the air or using sprinklers to wet the building envelope. Mechanical evaporative cooling systems also exist.
<i>Main characteristics</i>	-
<i>Power range</i>	Compression cooling: from few kW to MW. Adsorption cooling: from few kW to MW Natural cooling: N/A
<i>Technology interdependencies</i>	Better thermal performance of the building envelope and lower heat gains through glazing give rise to lower cooling needs.  Passive cooling can realize synergies with mechanical cooling systems and storage systems. Adsorption cooling permits synergies with solar thermal, storage systems, cogeneration plants and district heating and cooling systems.
<i>Advantages and disadvantages</i>	Mechanical cooling using ground and water is very effective. It can be coupled with PV production realizing a renewable scheme.  The advantages of absorption cooling machines are low electrical power requirements, fewer moving parts, limited noise, and the use of refrigerants with a low Global Warming Potential (GWP). Disadvantages include a high rate of heat rejection, limited unit selection and support, large physical size and weight, and toxicity of ammonia absorbent. Maintenance can be problematic though it is a mature technology.  Potential of ventilation and ground exchange cooling is very interesting. Limitations are connected to the cooling power reached and extension of buried channel on one hand and envelope openings on the other. Evaporative cooling is connected to dry warm air condition, high levels of humidity preclude the use of this technique.
<i>Financial data: investment, operation and maintenance</i>	The cost of installed kW is around 400€ for compression systems and 800€ for adsorption systems. Maintenance costs are lower for adsorption than for compression systems, around 2% and 4% of installation cost respectively. The expected life-time is up to 15 years; Natural ventilation and evaporative cooling costs are very dependent on the specific situation.
<i>Environmental issues</i>	Compression cooling need electrical energy
<i>Development potential</i>	The share of residential heat supplied by heat pumps globally needs to triple by 2030. Policies therefore need to address barriers to adoption, including high upfront purchase prices and operational costs.



	<p>In many markets, installed costs for heat pumps relative to potential savings on energy spending (e.g. when switching from a gas boiler to an electric heat pump) often mean that heat pumps may be only marginally less expensive over 10-12 years, even with their higher energy performance.</p> <p>Recent works concerning indirect evaporative cooling based on Maisotsenko-cycle have shown considerable potential towards enhancing the performance and cooling capacity of IEC system for building cooling.</p>
<p><i>References</i></p>	<p><u>Compression cooling:</u></p> <p>[1] doi.org/10.1039/C2EE22653G</p> <p>[2] doi.org/10.1016/j.apenergy.2010.06.014</p> <p><u>Adsorption cooling:</u></p> <p>[3] dx.doi.org/10.1.1.473.8896</p> <p>[4] <a href="https://en.wikipedia.org/wiki/Solar_thermal_collector">https://en.wikipedia.org/wiki/Solar_thermal_collector</a></p> <p><u>Natural ventilation:</u></p> <p>[5] doi.org/10.1016/j.egypro.2015.11.355, <a href="https://doi.org/10.1016/0960-1481(96)88855-0">https://doi.org/10.1016/0960-1481(96)88855-0</a></p> <p><u>Ground heat exchange:</u></p> <p>[6] doi.org/10.1186/s40517-015-0036-2</p> <p><u>Evaporative cooling:</u></p> <p>[7] doi.org/10.7763/IJESD.2015.V6.571</p>

### 3.2.4. Ground, water and air source heat pumps connected to district heating

Ground, water and air source heat pumps connected to district heating	
<p><i>Description</i></p>	<p>A heat pump takes heat or cool from rock, soil, lake or air, and transfers it to the property's heating system. The type of heat pump that is suitable for each application depends mainly on how much of the heating/cooling and hot water requirement needs to be covered and on the natural conditions near the installation area.</p> <p>When comparing different heat pumps, it is important to look at the seasonal coefficient of performance, the SCOP value. The higher the value, the more efficient the pump. Unlike many other types of heat sources, a heat pump requires a low temperature heat emission system, which means that the water for the elements needs to have a relatively low temperature in order for the heat pump to run optimally.</p> <p>An application of heat pumps is through integration into district heating networks.</p> <p>The renovation of the Slakthus area (Kylhusets kunder) in Stockholm in Sweden, where 6% of the total heat delivered to district grids is produced by heat pumps [1], is a recent example of such an application (2018). Excess heat from the cooling processes is recycled through an <i>Open District Heating™</i> grid to the district heating network via three heat pumps. There is a central cooling plant (kylmaskin) with a pipeline network, as illustrated in Figure 23, which delivers cooling to a number of food industry properties in the area. The area's production facility for cooling has a capacity of 2.3MW. Heat is recovered from the cooling unit's refrigerant to the district heating supply with three heat pumps. The plant is dimensioned to provide a cooling power of 989kW and a heat output of 1,228kW. The non-recycled condenser heat is supplied to the outdoor air via an optional closed cooling tower (kyltorn).</p> <p>The diagram illustrates the energy flow in the Slakthus area. At the bottom, a red line represents the district heating network (Fjärrvärme). Three heat pumps (Värmepump) are shown in the middle, connected to the network. Above them is a central cooling plant (Kylmaskin) and a cooling tower (Kyltorn). Arrows indicate the flow of heat and cooling between these components and the food industry customers (Kylhusets kunder) represented by buildings at the top.</p>
	<p>Figure 23. The application of the Slakthus area in Stockholm, which combines district heating (fjärrvärme) and heat pumps (värmepump). Image: <a href="http://openfjarrvarme.se">openfjarrvarme.se</a></p> <p>The heat pumps have been provided with sub-coolers. Incoming return water first passes all the sub-coolers in parallel, then it is led through the condensers in series. The connection</p>

principle increases the plant's performance by about 15%–20% and the efficiency (COP) increases from 4.2 to 4.6 [2].

The heat supply from the heat pump installation to the open district heating needs to follow the requirement for the supply temperature. When the system cannot achieve the temperature requirement, the heat pumps are switched off and the existing cooling tower is automatically switched on.

An example of combined air-water heat pumps and district heating system that is being used since 2017, is shown in Figure 24, a data centre where there are lots of servers that generate heat and therefore need to be cooled. This is usually done with a cooling machine, and the cooled off excess heat is then transported to a cooling tower where it is blown away [3]. By instead cooling the data centre with the help of one or more heat pumps, the excess heat can be delivered to the district heating network and used for heating the city instead of being blown away.

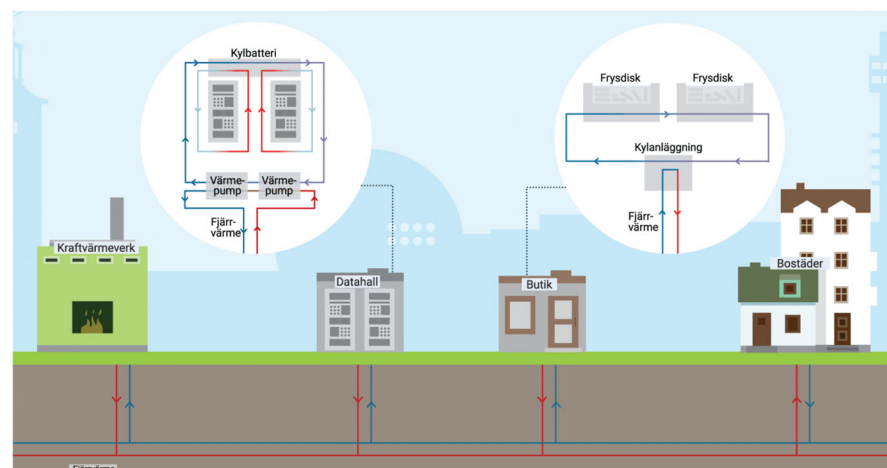

Figure 24. A system that combines air-water heat pumps and district heating in Sweden 2017 [3].

New combinations of heat pumps and district heating systems have been investigated such as the combination of these two in the manufacturing of hybrid heat pumps (together with district heating depending on the prices) and low temperature district heating (using heat pumps for the domestic hot water). [4]

A recent research was conducted by the Research Institutes of Sweden (RISE), Effsys Expand and five well-known Swedish heat pump manufacturers, investigating the integration of heat pumps in district heating systems. [5] In the scenario of low temperature district heating systems for small-scale applications, individual apartments, the design of heat pumps requires a tank for domestic hot water. Otherwise, the power output from the heat pump will be too high. For large-scale applications, multi-family houses, a central position of

the heat pump is advised, although the heat losses from the domestic hot water circulation are increased compared to separate heat pump installation for each apartment.

#### Ground-source heat pump

A ground-source heat pump extracts geothermal heat. The bedrock keeps a constant temperature all year round, which is good for the heat pump's efficiency and saving potential. The heat is collected through a number of boreholes (energy wells) which are often about 150 metres to 200 metres deep. If the wells are too close together, their capacity may deteriorate. Since the well has a very long service life (much longer than the heat pump), it is important that the drilling takes place in the best way.

Despite the higher investment cost, the relatively low running costs make geothermal heat an interesting alternative.

In Sweden, for example, about one fifth of the buildings used ground source heat pumps, making it a leading country within this technology. [6]

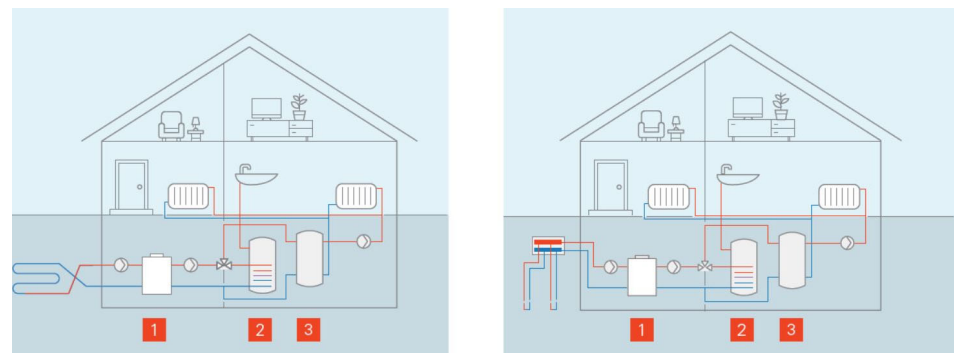

1. Ground-water heat pump (Left: with horizontal loop system, Right: with vertical boreholes)
2. Domestic hot water storage tank
3. Heating water buffer

Figure 25. Illustration of a small-scale ground-water heat pump. Image: viessmann.se [7]

Most applications include horizontal loop systems, as it is substantially cheaper than vertical boreholes, up to 30%. Figure 25 illustrates the components of both alternatives for a small-scale application. The drawback of horizontal loop systems is that they need a considerable ground area, so when the area of the property is limited, the vertical boreholes is the only ground solution. Generally, it is more efficient the deeper into the ground they reach as the temperature of the ground becomes more stable.

#### Water-source heat pump (sea, lake, groundwater)

If there is a lake or sea nearby the area of interest, there is the option of water-water heat pumps. The principle is the same as for rock heat, but in this case the collector hose is placed

	<p>on the bottom of the lake instead. In a groundwater heat pump system, "warm" groundwater is pumped up to the heat pump, which after cooling, is pumped back to another well. The permit process for sea, lakes and groundwater heat pumps can often be complicated when it comes to sensitive environments.</p> <p><u>Air-water heat pump</u></p> <p>An air-water heat pump extracts low quality heat in the outdoor air to produce waterborne heat and hot water. The heat can be recovered even if the outside temperature drops to - 20°C. However, the pump has lower efficiency at lower outdoor temperatures and needs a complementary heat source for really cold days, usually an electric heater. It is a heating system which can also give hot water at a low cost and can cover a significant part of a house's total need for heat and hot water.</p>
<i>Main characteristics</i>	<p>Ground-source heat pumps have higher energy efficiency than other heat pump sources, and have higher saving potential despite the high investment cost.</p> <p>A ground-source heat pump is characterized by the lowest value of annual exploitation costs in comparison to gas boilers and electric heating. The possibility to cool a residential building during summer, gives significant savings in comparison to more expensive air-conditioning or mechanical ventilation systems.</p> <p>A water-source heat pump can reach an even higher efficiency but it is less common.</p> <p>An air-water heat pump does not require any fuel filling. An exhaust air-water heat pump has potential to take advantage of the heat that otherwise would have to be removed by cooling systems.</p> <p>Since this kind of heat pump (air source) does not require any intervention on site during installation, the investment costs are lower compared to other heat pumps that produce water-borne heat.</p>
<i>Power range</i>	<p>A large-scale heat pump unit is defined as a unit that has a heat power capacity greater or equal to 1MW and has at least one compressor, one evaporator and one condenser. In Sweden, for example, large heat-pump applications range from 1MW to 50MW. [1]</p> <p>For air-water heat pumps the range lies between 5.7–84.6kW. Heat pump capacities above 60kW are normally covered by more than one heat pump unit.</p>
<i>Technology interdependencies</i>	<p>Since the well has a very long service life (much longer than the heat pump), it is important that the drilling takes place in the best way. It is important that the local geology and the</p>

	<p>heating and cooling requirements of the building/neighbourhood are assessed. It is recommended that an industry-connected and certified drilling company is involved.</p> <p>In the example of Sweden there has traditionally been a strong competition between the heat pump and district heating industries. By finding new applications, the two industries both can benefit from coexisting.</p> <p>The location of the heat pumps in series with district heating is not an optimal solution considering the district heating return temperature. The best compromise for combining heat pump and district heating is to make the connection in parallel, but then the control strategy becomes more complex. [5]</p>
<p><i>Advantages and disadvantages</i></p>	<p><u>Advantages of heat pumps in district heating:</u></p> <ul style="list-style-type: none"> <li>- Heat pumps can reduce the cost when the Combined Heat and Power (CHP) plants are expensive.</li> <li>- Combined applications of heat pumps in district heating grids provide flexibility in the electricity system. The heat pumps can operate when the electricity prices are low and shut down during the period when the prices are high.</li> </ul> <p><u>Ground source</u></p> <p>Advantages:</p> <ul style="list-style-type: none"> <li>- High efficiency (COP)</li> <li>- They are invisible, silent systems with low environmental impact.</li> <li>- They have lower exploitation costs than air-source heat pumps, which are unprofitable in low temperature periods.</li> <li>- They have smaller requirements concerning maintenance and conservation than water-source heat pumps.</li> </ul> <p>Disadvantages:</p> <ul style="list-style-type: none"> <li>- They require higher investment cost.</li> <li>- The drilling technique has to be considered because if the installation is poorly performed various problems may arise.</li> </ul> <p><u>Water source</u></p> <p>Advantages:</p> <ul style="list-style-type: none"> <li>- They have the same advantages as ground source heat pumps.</li> </ul> <p>Disadvantages:</p> <ul style="list-style-type: none"> <li>- They can be applied when there is a near, or not too deep, water source.</li> <li>- It is more complex than other heat pump systems.</li> </ul> <p><u>Air source</u></p> <p>Advantages:</p> <ul style="list-style-type: none"> <li>- They have substantially lower installation cost.</li> <li>- Does not require any on-site intervention</li> </ul>

	<p>Disadvantages:</p> <ul style="list-style-type: none"> <li>- They have lower efficiency than other heat pump sources, especially for cold climates.</li> <li>- They are noisier than other heat pumps.</li> <li>- Shorter lifespan, around 15 years, when compared to ground-source heat pumps, around 20-25 years.</li> </ul>												
<i>Typical energy data and prices</i>	<p>Table 11. Data concerning the efficiency of the system is coming from different heat pump producers.</p> <table border="1"> <thead> <tr> <th>Nominal Power (B0 / W35) EN14825</th> <th>Efficiency for 35°C system [-]</th> <th>Efficiency for 55°C system [-]</th> <th>Cost [€/kW]</th> </tr> </thead> <tbody> <tr> <td>540kW (9 x 60kW)*</td> <td>4.65</td> <td>3.03</td> <td>327.2* (full system)</td> </tr> <tr> <td>1.056MW (12 x 88kW)**</td> <td>5.3</td> <td>4.32</td> <td>195.4 ** (only heat pump)</td> </tr> </tbody> </table> <p>*NIBE [9],  **Thermia: The price here includes only the cost per kW for the heat pump unit.</p> <p>Adding more heat pumps of 88kW can produce a larger-scale system. As the system gets larger, the efficiency of the system slightly decreases due to losses. However, according to the specific design the cost may vary.</p>	Nominal Power (B0 / W35) EN14825	Efficiency for 35°C system [-]	Efficiency for 55°C system [-]	Cost [€/kW]	540kW (9 x 60kW)*	4.65	3.03	327.2* (full system)	1.056MW (12 x 88kW)**	5.3	4.32	195.4 ** (only heat pump)
Nominal Power (B0 / W35) EN14825	Efficiency for 35°C system [-]	Efficiency for 55°C system [-]	Cost [€/kW]										
540kW (9 x 60kW)*	4.65	3.03	327.2* (full system)										
1.056MW (12 x 88kW)**	5.3	4.32	195.4 ** (only heat pump)										
<i>Energy performance</i>	<p>An average coefficient of performance for ground-heat pump systems is about 4. [9]  An average seasonal coefficient of performance (SCOP) for air-heat pump systems is about 3. [10] The SCOP is chosen here as more representative value, since the efficiency decreases during the winter months.  According to a Swedish study, an air source system that has an efficiency from 2.8 to 4.1 in Malmö (lat. 55°), corresponds to between 2.3 and 2.6 in Luleå (lat. 65°) [11].</p>												
<i>Financial data: investment, operation and maintenance</i>	<p>For both district heating and heat pumps, the heating cost consists of a fixed part and a variable part. The fixed part is the capital cost as well as fixed fees for electricity networks and district heating networks. This is by far the major part of the fixed cost, that includes operation and maintenance costs as well. The variable cost mainly relates to energy costs.</p> <p>When combined with district heating, the operation can be selected based to actual power market conditions in order to have a relatively low operation cost. The heat pump would be mainly used during the winter months, while district heating would dominate in the summer, according to current seasonal prices of district heating and the electricity prices.</p> <p>Research has shown that a hybrid heat pump can have a substantially increased investment cost compared to a traditional heat pump but it has the same payback time. [5]</p>												

<p><i>Environmental issues</i></p>	<p>Heat pumps in large-scale solutions can contribute to reduced primary energy supplies, carbon dioxide emissions and costs making use of strategically advantageous heat sources.</p> <p>An important aspect concerning environmental impacts is the leakage of refrigerants, which must be eliminated.</p> <p>It is more likely that air-water heat pumps cause noise problems.</p>
<p><i>Development potential</i></p>	<p>The market for small ground-source heat pumps (GSHP) has stabilised during the last years, but there is a steady market growth for larger systems for residential buildings as well as in the commercial and institutional sector. [6] Systems with increasing size, deeper boreholes and higher capabilities are investigated. The distribution and technology development of the GSHP are therefore progressing actively. Research related to heat pumps and geothermal energy is carried out to include energy storage from summer to winter. Areas of interest concerning the district heating network include large cavern thermal energy systems for high-temperature storage and cold networks with distributed heat pumps.</p> <p>Another innovative technology that includes heat pumps called ectogrid™ [12]. The system circulates, reuses and shares the energy within a district. This will dramatically decrease the need for supplied energy and save costs. The innovation is not in the components of the system but in the new and novel way they are put together. The heat pumps and the cooling machines can operate against more favourable temperature ranges and the thermal energy distribution becomes more efficient and removes energy losses as well as all traditional large scale production units. Only one thermal grid is needed, but it serves several purposes – thermal distribution for both heating and cooling as well as storage and flexibility. A basic principle is that one should harvest all thermal energy flows (heating and cooling) and balance them against each other.</p> <p>This flexible grid connects the city that distributes thermal energy flows between neighbours. Each building connected to the system uses heat pumps and cooling machines. The buildings make energy “deposits or withdrawals” from the grid, which means that the energy demands from all the buildings are balanced against each other.</p> <p>Energy is only added to the system when needed. If there is a surplus of energy, or if other energy demands need to be prioritized, the system’s temperature can be raised or lowered. Depending on the demand for heating and cooling, it can also change temperature. It works like a giant thermal battery – making more room for intermittent renewable energy, as Figure 26 shows. The system does not have any distribution losses, as it operates with the same low temperature as the surrounding earth. It can be applied in district, neighbourhood or city level and lean on district heating grid.</p>



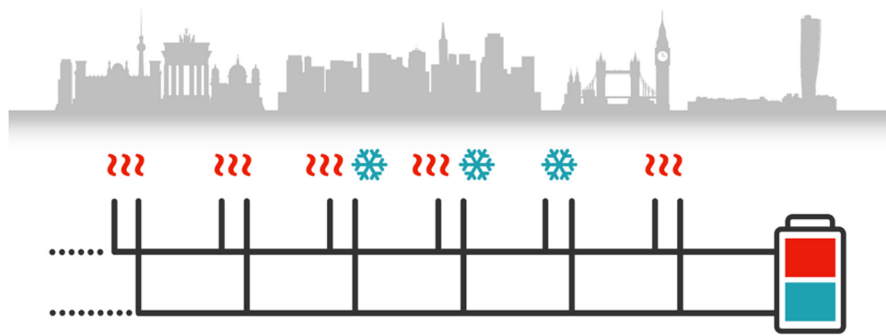

Figure 26. Ectogrid™ works like a giant thermal battery and has no distribution losses as it operates with the same low temperature as the surrounding earth. Image: ectogrid.com

The world's first ectogrid™ is available at Medicon Village in Lund, Sweden, a life science park, Figure 27. Effective use of the surplus energy that arises in Medicon Village operations drastically reduces the entire area's energy needs. Construction started in autumn 2017, the physical installation of the grid started in the summer of 2018 and by 2020 all buildings are expected to be connected to the system and reach the full capacity. [13, 14]. The temperature in the uninsulated grid can vary freely between 5°C and 40°C depending on the demands of heating and cooling and the temperature of the surrounding earth. As the system operates at such low temperatures, it can make use of all thermal waste energy available in buildings and in a city. Software then uses the real-time data to steer and optimize the energy flow and storage.



Figure 27. An illustration of the ectogrid™ at Medicon Village. Image: ectogrid.com

As discussed above, heat pumps recovering heat from local cooling devices and places that produce heat, like data centres, to district systems is under current development.

*References*

[1] Averfalk H, Ingvarsson P, Persson U, Gong M, Werner S. Large heat pumps in Swedish district heating systems. *Renewable and Sustainable Energy Reviews*.

2017;79:1275-84.

- [2] Kylcentralen i Slakthusområdet - Öppen Fjärrvärme. Öppen Fjärrvärme. [www.oppenfjarrvarme.se/case/kylhuset-i-slakthusområdet/](http://www.oppenfjarrvarme.se/case/kylhuset-i-slakthusområdet/). Published 2018.
- [3] Så funkar Öppen Fjärrvärme - Öppen Fjärrvärme. Öppen Fjärrvärme.se <https://www.oppenfjarrvarme.se/om-oss/sa-funkar-oppen-fjarrvarme/>. Published 2017.
- [4] Lindahl M. New ways of combining Heat Pumps and District Heating. Heat Pumping Technologies, HTP, Magazine [Internet]. Vol. 36 No. 3/2018. [issuu.com/hptmagazine/docs/hpt\\_magazine\\_no3\\_2018](http://issuu.com/hptmagazine/docs/hpt_magazine_no3_2018). Published 2018.
- [5] Lindahl M, Benson J, Walfridson T, Markusson C, Räftegård O, Gustafsson O. Värmepumpar i fjärrvärmesystem. 2018.
- [6] Gehlin S, Andersson O. Geothermal Energy Use, Country Update for Sweden. European Geothermal Congress Strasbourg, 2016.
- [7] Luft/vattenvärmepumpar | Viessmann. Viessmann.se, [viessmann.se/sv/bostadshus/varmepumpar/luftvattenvarmepumpar.html](http://viessmann.se/sv/bostadshus/varmepumpar/luftvattenvarmepumpar.html) . Published 2019.
- [8] Produkt NIBE F1345-60. Proffs.nibe.se. [proffs.nibe.se. proffs.nibe.se/nibedocuments/16111/F1345-60.pdf](http://proffs.nibe.se/nibedocuments/16111/F1345-60.pdf). Published 2015.
- [9] Vad säger värdet för COP om värmepumpen? | GreenMatch. Greenmatch.se. [www.greenmatch.se/blogg/2014/08/vad-saeger-vaerdet-foer-cop-om-vaermepumpen](http://www.greenmatch.se/blogg/2014/08/vad-saeger-vaerdet-foer-cop-om-vaermepumpen). Published 2019.
- [10] Vad säger värdet för COP om värmepumpen? | GreenMatch. Greenmatch.se. <https://www.greenmatch.se/blogg/2014/08/vad-saeger-vaerdet-foer-cop-om-vaermepumpen>. Published 2019.
- [11] Luftluftvärmepumpar 2009-2013. Energimyndigheten.se. <http://www.energimyndigheten.se/tester/tester-a-o/luftluftvarmepumpar-2009-2013/> Published 2014.
- [12] About - E.ON ectogrid. [ectogrid.com/about/](http://ectogrid.com/about/). Published 2019.
- [13] ectogrid™ | Energirevolutionen är här - E.ON. Eon.se. [www.eon.se/om-eon/innovation/ectogrid.html](http://www.eon.se/om-eon/innovation/ectogrid.html). Published 2019.
- [14] Jensen T. Game changing technology connects Medicon Village buildings. Mediconvillage.se. [www.mediconvillage.se/sv/game-changing-technology-connects-medicon-village-buildings](http://www.mediconvillage.se/sv/game-changing-technology-connects-medicon-village-buildings). Published 2018.

### 3.2.5. Solar Thermal

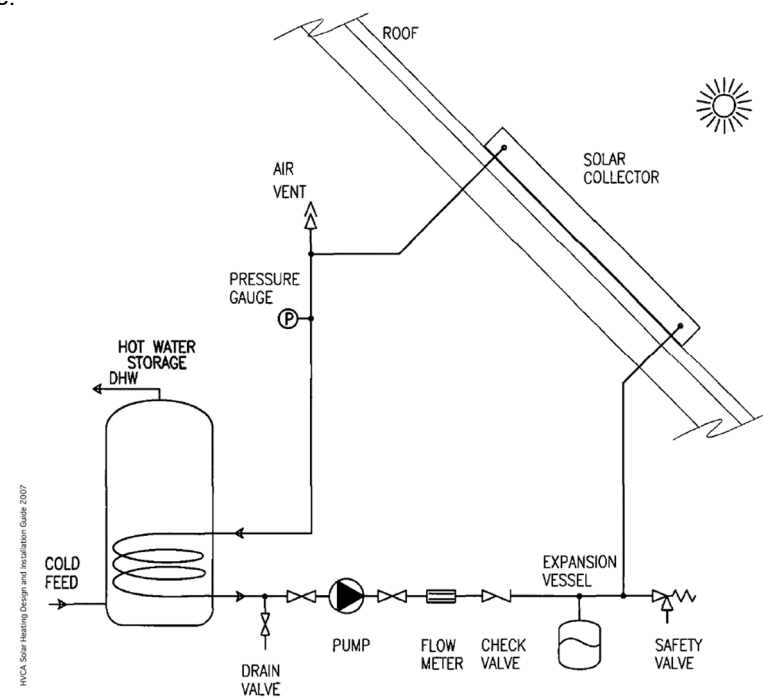
Solar Thermal	
<p><i>Description</i></p>	<p>Solar Thermal Systems refer to systems harnessing solar energy for generating thermal energy used in buildings for space heating and Domestic Hot Water (DHW). Advances in the adoption of the technology and its low cost, have made the solar systems very competitive solutions, for a large variety of contexts, such as residential, commercial and industrial for both standalone and grid connected installations [1].</p> <p>A typical system will include collectors to absorb solar radiation and convert that energy into heat that will be used to send hot water to the boiler in order to save fuel (Figure 28). Research shows that there are significant advantages in the collective implementation of solar thermal systems in districts. There is the possibility of integrating solar heat into existing district heating systems using combined Heat and Power plants [2]. Also, in the light of new requirements for decarbonisation of the built environment, solar thermal systems and photovoltaic systems compete for space in building roofs. In comparison with single building application, implementation of these systems in a group of buildings can be beneficial to take advantage of the scale effect, even if a district heating system is not available.</p>  <p>Figure 28. Schematic of a simple sealed solar thermal system Source: [3]</p>
<p><i>Main characteristics</i></p>	<p>The majority of the solar thermal systems installations is used for domestic hot water (95% of all installed glazed collectors), especially in single family housing (85%) [4]. Amongst the most used systems are the evacuated tube solar collectors and the glazed flat plate collectors. Being one of the most common solar systems, the glazed flat plate collectors</p>

	<p>are normally composed of modules ranging from 1.5 to 3m<sup>2</sup>, with a thickness varying between 4 and 10cm. Their average weight is 20kg/m<sup>2</sup> and are normally composed of glass, an air layer, a metal absorber, a hydraulic system and an insulation material. Energy is transported by a rigid insulated piping system (3-8cm diameter), which can present significant energy losses. The energy production ranges from 450 to 650kWh/m<sup>2</sup> per year [5]. There is an increasing trend of using solar thermal collectors to supply hot water in other contexts, such as larger residential and non-residential areas e.g. district heating in Europe. District solar heating and cooling are growing, but the largest applications can be found in the Middle East and North Africa regions [4] .</p>																
<i>Power range</i>	N/A																
<i>Technology interdependencies</i>	Synergies with district heating and cooling systems, as well as with building energy management systems																
<i>Advantages and disadvantages</i>	<p>The main advantages are connected with the fact that these systems reduce considerable amounts of energy consumption and related production of carbon emissions. The average system has a life cycle of around 25 years with a relative low maintenance.</p> <p>These systems also still have a large potential for government subsidies and incentives and they contribute to fuel price inflation independence.</p> <p>For a district heating system mainly heated by a fossil CHP-plant a solar thermal system may contribute to a positive reaction on changes in the electricity price market [2].</p> <p>However, and despite of the development of the technology, it continues to face a number of barriers, such as lack of information, and economic and technical issues[4].</p>																
<i>Typical energy data and prices for ST solutions for one country</i>	<p>Table 12. Typical energy data for solar thermal systems. (Adapted from [6]).</p> <table border="1"> <thead> <tr> <th><b>Type of system</b></th> <th><b>Optical yield</b></th> <th><b>Losses (W/m<sup>2</sup>K)</b></th> <th><b>Price (€)</b></th> </tr> </thead> <tbody> <tr> <td>Compact ThermoSyphon, Plane collector – 1.9m<sup>2</sup></td> <td>0.761</td> <td>3.39 W/m<sup>2</sup>K</td> <td>1.400</td> </tr> <tr> <td>Compact with forced circulation, plane collector, 2,14m<sup>2</sup></td> <td>0.78</td> <td>3.473 W/m<sup>2</sup>K</td> <td>3.183</td> </tr> <tr> <td>Compact with forced circulation vacuum tube collectors – 1,125m<sup>2</sup></td> <td>0.18</td> <td>0.18 W/m<sup>2</sup>K</td> <td>5.179</td> </tr> </tbody> </table>	<b>Type of system</b>	<b>Optical yield</b>	<b>Losses (W/m<sup>2</sup>K)</b>	<b>Price (€)</b>	Compact ThermoSyphon, Plane collector – 1.9m <sup>2</sup>	0.761	3.39 W/m <sup>2</sup> K	1.400	Compact with forced circulation, plane collector, 2,14m <sup>2</sup>	0.78	3.473 W/m <sup>2</sup> K	3.183	Compact with forced circulation vacuum tube collectors – 1,125m <sup>2</sup>	0.18	0.18 W/m <sup>2</sup> K	5.179
<b>Type of system</b>	<b>Optical yield</b>	<b>Losses (W/m<sup>2</sup>K)</b>	<b>Price (€)</b>														
Compact ThermoSyphon, Plane collector – 1.9m <sup>2</sup>	0.761	3.39 W/m <sup>2</sup> K	1.400														
Compact with forced circulation, plane collector, 2,14m <sup>2</sup>	0.78	3.473 W/m <sup>2</sup> K	3.183														
Compact with forced circulation vacuum tube collectors – 1,125m <sup>2</sup>	0.18	0.18 W/m <sup>2</sup> K	5.179														
<i>Energy performance</i>	Adequate installations can provide 60% of domestic hot water energy in a single family house [7].																

<p><i>Financial data: investment, operation and maintenance</i></p>	<p>Initial investment depends on the size and type of installation. However, in order to calculate the economic viability of a solar thermal system, operating costs have also to be considered. Operating costs of such a system have been estimated to be between 1 to 1.5%/year of the initial investment. However, these studies show a payback time of 2.7 years and life cycle savings of 2240 Euros with an electricity backup system [8].</p>
<p><i>Environmental issues</i></p>	<p>The environmental impacts of solar thermal systems are closely related with the additional energy that is consumed and therefore depends on the type of energy backup that is used [9]. There is also considerable environmental impacts related with the materials used in the composition of the solar thermal system, namely in the solar collector. However, some studies indicate that the energy spent for the manufacturer and installation of solar systems can be recovered in about 13 months [8]. In terms of environmental performance it is worthy to highlight the potential savings from the installation of such a system. There is evidence pointing at 70% of energy savings, when compared with a system with no solar heating [8].</p>
<p><i>Development potential</i></p>	<p>In terms of market development, a report from 2018 indicates that solar installation supporting district heating systems, as well as heating and cooling applications in commercial and industrial settings have gained interest and scale in recent years [10], with a particular incidence in the use of heat pump technologies (e.g.[11]).</p> <p>Solar thermal technologies have continued to evolve. For example, polymeric collectors are a different approach with significant weight and cost reduction. Another significant advantage is the introduction of different filling gases in solar collectors.</p>
<p><i>References</i></p>	<p>[1] M. Malinowski, J. I. Leon, and H. Abu-Rub, "Solar Photovoltaic and Thermal Energy Systems: Current Technology and Future Trends," <i>Proc. IEEE</i>, vol. 105, no. 11, pp. 2132–2146, Nov. 2017.</p> <p>[2] C. Winterscheid, J.-O. Dalenbäck, and S. Holler, "Integration of solar thermal systems in existing district heating systems," <i>Energy</i>, vol. 137, pp. 579–585, Oct. 2017.</p> <p>[3] "BSEE- Building Services &amp; Environmental Engineering." [Online]. Available: <a href="http://www.bsee.co.uk">http://www.bsee.co.uk</a>. [Accessed: 19-Mar-2019].</p> <p>[4] "Integrating Solar thermal In Buildings-a quick guide for architects and Builders."</p> <p>[5] IEA SHC Task 41, "SOLAR ENERGY SYSTEMS IN ARCHITECTURE- integration criteria and guidelines."</p> <p>[6] S. A. CYPE Ingenieros, "Gerador de Preços. Portugal," 2018. .</p> <p>[7] The Energy Saving Trust, "Here comes the sun: a field trial of solar water heating systems."</p> <p>[8] S. Kalogirou, "Thermal performance, economic and environmental life cycle analysis of thermosiphon solar water heaters," <i>Sol. Energy</i>, vol. 83, no. 1, Jan. 2009.</p> <p>[9] A. De Laborderie <i>et al.</i>, "Environmental Impacts of Solar Thermal Systems with Life Cycle Assessment," 2011.</p> <p>[10] W. Weiss and M. Spörk-Dür, "Solar Heat Worldwide Detailed Market Figures 2016 2 0</p>

	<p>18 EDITION Global Market Development and Trends in 2017," 2018.</p> <p>[11] Lazzarin, R. (2020). Heat pumps and solar energy: A review with some insights in the future. International Journal of Refrigeration. <a href="https://doi.org/10.1016/j.ijrefrig.2020.03.031">https://doi.org/10.1016/j.ijrefrig.2020.03.031</a></p>
--	---

### 3.2.6. Photovoltaic solar panels (PV)

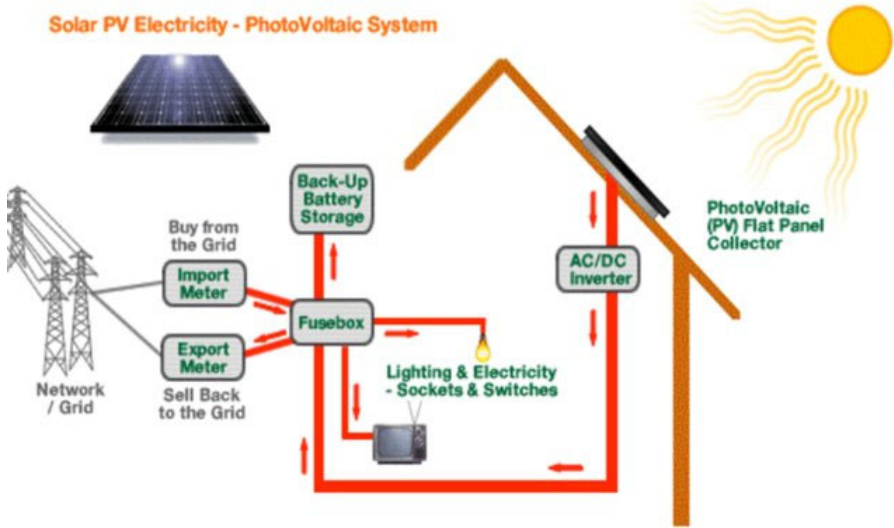
Photovoltaic solar panels (PV)	
<p><i>Description</i></p>	<p>The main purpose of PV panels is to absorb the energy in sunlight and to produce electricity.</p> <p>Photovoltaics cells can be divided into two main categories: crystalline silicon (mono- and multi-crystalline) and thin film (e.g. amorphous silicon and copper indium gallium selenide (CIGS)). The crystalline silicon technologies have by far the highest market share.</p> <p>PV panels can either be mounted on racks, typically on rooftops, or on the ground in larger production sites, or they can be integrated in the building façade (BIPV). They can be mounted using a solar tracking system in order to improve their efficiency.</p>  <p>Figure 29. Schematic example of a solar Photovoltaic system. Source: [1]</p>
<p><i>Main characteristics</i></p>	<p>PV systems are generally modular, composed of photovoltaic cells of semiconductor materials which produce a specific voltage and current when exposed to sunlight. PV systems have experienced a rapid price reduction in the last years, and have gone from being a costly electricity production technology to become a highly economically sustainable solution [2].</p> <p>Roof mounted PV panels are well suited as standalone retrofit installation, while BIPV systems are mainly relevant for new buildings or in combination with façade renovation.</p>
<p><i>Power range</i></p>	<p>Can be installed in all sizes. 1-10kW on single family houses, 50 to 500 kW for commercial buildings and apartment blocks and above 1MW for industrial power plant applications.</p>
<p><i>Technology interdependencies</i></p>	<p>PV panels produce power only during sunshine, and the production is often not in phase with the electric consumption of a residential building or neighbourhood. It is usually more economical for a building to utilize the produced power itself instead of selling it to the grid</p>

	<p>(country dependent). A combination of PV and battery to increase self-consumption can be beneficial.</p> <p>At district level there are studies pointing to the potential of integrating existing Combined Heat and Power (CHP) plants with PV generation [3].</p> <p>Application of BIPV replaces other façade elements. It is important to take this into account when calculating the total cost of the renovation.</p>																
<p><i>Advantages and disadvantages</i></p>	<p>PV is one of few cost-efficient local electricity production technologies. In addition, it is noiseless, and does not consume fuel or other consumables.</p> <p>An important disadvantage/challenge of PV systems is that the electricity production is not synchronised with the consumption. This normally means that part of the produced electricity must be exported (normally for a lower selling price than the cost of buying it back) or stored. This reduces the profitability of the PV system. In some countries there are also restrictions in allowed export power, which can limit the allowable system size. It is also a challenge that in many countries the import/export cost of electricity is calculated at individual meter and the economic benefit of local energy exchange cannot be exploited. However, new legislations are under development to increase the economic benefits of renewable energy communities, e.g. by the European Directive 2018/2001. For large systems in neighbourhoods, a large mismatch in production and consumption can also be related to challenges with the distribution grid, mainly if the net peak production is higher than the grid design load. The degree of mismatch is largely dependent on the buildings energy demand, size of the system and the location.</p>																
<p><i>Typical energy data and prices for PV solutions for one country</i></p>	<p>The table below gives typical values for peak production capacity, efficiency and price for commercially available PV panels.</p> <p>Table 13. Typical values for peak production capacity, efficiency and price.</p> <table border="1" data-bbox="466 1505 1369 1742"> <thead> <tr> <th>PV</th> <th>kWp [W/m<sup>2</sup>]</th> <th><math>\eta</math> %</th> <th>Price [€/Wp]</th> </tr> </thead> <tbody> <tr> <td>Mono -Si</td> <td>150-190</td> <td>15-19</td> <td>1.5-2</td> </tr> <tr> <td>Multi-Si</td> <td>130-190</td> <td>13-15</td> <td>1.5-2</td> </tr> <tr> <td>a-Si</td> <td>50-80</td> <td>5-8</td> <td>?</td> </tr> </tbody> </table> <p>Source: [4], [5].</p>	PV	kWp [W/m <sup>2</sup> ]	$\eta$ %	Price [€/Wp]	Mono -Si	150-190	15-19	1.5-2	Multi-Si	130-190	13-15	1.5-2	a-Si	50-80	5-8	?
PV	kWp [W/m <sup>2</sup> ]	$\eta$ %	Price [€/Wp]														
Mono -Si	150-190	15-19	1.5-2														
Multi-Si	130-190	13-15	1.5-2														
a-Si	50-80	5-8	?														
<p><i>Energy performance</i></p>	<p>The efficiency of new commercial PV modules is normally in the range of 15-20%. Laboratory tests have achieved around 25% efficiency. Performance ratio of modern PV-systems typically range between 80-90% [4].</p>																



<p><i>Financial data: investment, operation and maintenance</i></p>	<p>Cost of PV-systems are highly dependent on size, type of installation, and country. Typically, small scale roof mounted PV systems (1-10 kW<sub>p</sub>) cost in the range 1.5-2 €/W<sub>p</sub>. For larger scale system cost can be reduced down to 1 €/W<sub>p</sub> (Germany) [4].</p>
<p><i>Environmental issues</i></p>	<p>In BIPV or building related implementation of this technology, the main environmental impacts are related with the need for mining raw materials and the energy intensity with relation to the high temperatures necessary for production of PV cells.</p>
<p><i>Development potential</i></p>	<p>PV panels are still under development, and the market is growing. New technologies such as Organic PVs are sought to be available in a recent future. For established technologies, both an increase in efficiency and a reduction in price is expected in future.</p> <p>Some prioritized areas are:</p> <ul style="list-style-type: none"> <li>• Silicon feedstock for high-efficiency cells.</li> <li>• New PV cells e.g. photo-electro-chemical, polymer cells and nanostructured cells.</li> <li>• Inverters; increased technical lifetime, high efficiency and lower costs.</li> <li>• System technology; incl. integration in the overall electricity system.</li> <li>• Building integration of PV modules, design and aesthetics.</li> </ul>
<p><i>References</i></p>	<p>[1] G. Devlin, "A Feasibility Analysis of Photovoltaic Solar Power for Small Communities in Ireland," <i>Open Renew. Energy J.</i>, vol. 4, no. 1, pp. 78–92, 2011.</p> <p>[2] M. Hosenuzzaman, N. A. Rahim, J. Selvaraj, M. Hasanuzzaman, A. B. M. A. Malek, and A. Nahar, "Global prospects, progress, policies, and environmental impact of solar photovoltaic power generation," <i>Renew. Sustain. Energy Rev.</i>, vol. 41, pp. 284–297, Jan. 2015.</p> <p>[3] C. Winterscheid, J.-O. Dalenbäck, and S. Holler, "Integration of solar thermal systems in existing district heating systems," <i>Energy</i>, vol. 137, pp. 579–585, Oct. 2017.</p> <p>[4] Fraunhofer ISE, "PHOTOVOLTAICS REPORT," 2019.</p> <p>[5] International Renewable Energy Agency, IRENA cost and competitiveness indicators, no. December. 2017.</p>

### 3.2.7. PVT

PVT	
<p><i>Description</i></p>	<p>A PVT collector is a solar energy device that uses PV as a thermal absorber and produces both electrical and thermal energy. PVT modules are produced in different types, also for different applications.</p> <p>On the one hand PVT collectors are used for domestic hot water preparation and to support heating. On the other hand PVT collectors can be also used as source for heat pumps or to regenerate geothermal probes. Figure 30 shows the classification of PVT modules according to [1]. A specific application can be night cooling by unglazed PVT alternative.</p> <div data-bbox="491 694 1388 1265" data-label="Diagram"> <pre> graph TD     PVT --&gt; FlatPlateLiquid[Flat plate liquid]     PVT --&gt; FlatPlateAir[Flat plate air]     PVT --&gt; Concentrator[Concentrator]     PVT --&gt; VacuumTube[Vacuum tube]          FlatPlateLiquid --&gt; Uncovered[Uncovered]     FlatPlateLiquid --&gt; Covered[Covered]          Uncovered --&gt; Insulation[With / without thermal insulation]     Insulation --&gt; HeatExchanger[With / without add-on heat exchanger/ absorber]          Covered --&gt; PVOnAbsorber[PV on absorber]     Covered --&gt; PVUnderGlass[PV under glass cover]          FlatPlateAir --&gt; PVTIntegrated[PVT integrated module]     FlatPlateAir --&gt; AirCollector[Air collector with small PV module for ventilation]     FlatPlateAir --&gt; VentilatedPV[Ventilated PV with heat recovery]          Concentrator     VacuumTube     </pre> </div> <p>Figure 30. Classification of PVT modules (source: [1])</p> <p>Based on the figure above [1] following categories of PVT collectors can be defined:</p> <ul style="list-style-type: none"> <li>• 1a: Flat plate water uncovered without thermal insulation</li> <li>• 1b: Flat plate water uncovered without thermal insulation, thermal absorber as separate unit under PV module(s)</li> <li>• 2a: Flat plate water uncovered with thermal insulation</li> <li>• 2b: Flat plate water uncovered with thermal insulation thermal absorber as separate unit under PV module(s)</li> <li>• 3: Flat plate water covered, PV cells placed on absorber</li> <li>• 4: Flat plate water covered, PV cells placed directly under glass cover</li> <li>• L1: Flat plate air (heating and electricity in one component)</li> <li>• L2: Air collector + (small) PV module only used for ventilation power</li> <li>• L3: Ventilated PV module with heat recovery system for ventilation system</li> <li>• Conc: Concentrating sunlight to a smaller receptive area</li> <li>• Vac: Vacuum tubes above a PV laminate or vacuum tubes containing PV cells</li> </ul>
<p><i>Main characteristics</i></p>	<p>Approximately 10% of the solar irradiation on a crystalline photovoltaic cell is reflected and cannot be used, 90% is absorbed by the cell. From this 90% only a small percentage (about 17%) is converted into electricity. The rest is converted into heat. In an ordinary photovoltaic</p>

	<p>module this heat cannot be used and is lost. It raises the temperature of the cell and can thus have a negative effect on the electrical efficiency of the module.</p> <p>The basic idea behind PVT collectors is to utilise the solar heat that is produced in PV cells. A simple option for accomplishing this is to attach a fluid-filled metal heat absorber on the rear of a PV module. Instead of the heat being released to the environment, it can then be transferred to a heat sink with the help of the heat transfer fluid. In this way, a large proportion of the solar energy absorbed by the cell can be utilised so that PVT collectors attain higher surface-specific energy yields than standard PV modules.</p>																																																							
<p><i>Power range</i></p>	<p>[1] carried out a market analysis of PVT products which were at the time of the survey available on the market. 92 different PVT modules were identified. The power range of the identified products range between:</p> <p>Table 14. Power range and price for typical PVT systems.</p> <table border="1" data-bbox="525 866 1370 1456"> <thead> <tr> <th>Type</th> <th>minimum power [Wp]</th> <th>maximum power [Wp]</th> <th>minimum power per m<sup>2</sup> [Wp/m<sup>2</sup>]</th> <th>maximum power per m<sup>2</sup> [Wp/m<sup>2</sup>]</th> </tr> </thead> <tbody> <tr> <td><b>1a</b></td> <td>190</td> <td>570</td> <td>126</td> <td>188</td> </tr> <tr> <td><b>1b</b></td> <td>250</td> <td>290</td> <td>156</td> <td>181</td> </tr> <tr> <td><b>2a</b></td> <td>76</td> <td>300</td> <td>12</td> <td>188</td> </tr> <tr> <td><b>2b</b></td> <td>165</td> <td>250</td> <td>103</td> <td>192</td> </tr> <tr> <td><b>3</b></td> <td>180</td> <td>255</td> <td>120</td> <td>159</td> </tr> <tr> <td><b>4</b></td> <td>193</td> <td>193</td> <td>148</td> <td>148</td> </tr> <tr> <td><b>L2</b></td> <td>11</td> <td>36</td> <td>6</td> <td>9</td> </tr> <tr> <td><b>L3</b></td> <td>100</td> <td>285</td> <td>100</td> <td>178</td> </tr> <tr> <td><b>Conc</b></td> <td>250</td> <td>1500</td> <td>100</td> <td>250</td> </tr> <tr> <td><b>Vac</b></td> <td>100</td> <td>100</td> <td>59</td> <td>59</td> </tr> </tbody> </table>	Type	minimum power [Wp]	maximum power [Wp]	minimum power per m <sup>2</sup> [Wp/m <sup>2</sup> ]	maximum power per m <sup>2</sup> [Wp/m <sup>2</sup> ]	<b>1a</b>	190	570	126	188	<b>1b</b>	250	290	156	181	<b>2a</b>	76	300	12	188	<b>2b</b>	165	250	103	192	<b>3</b>	180	255	120	159	<b>4</b>	193	193	148	148	<b>L2</b>	11	36	6	9	<b>L3</b>	100	285	100	178	<b>Conc</b>	250	1500	100	250	<b>Vac</b>	100	100	59	59
Type	minimum power [Wp]	maximum power [Wp]	minimum power per m <sup>2</sup> [Wp/m <sup>2</sup> ]	maximum power per m <sup>2</sup> [Wp/m <sup>2</sup> ]																																																				
<b>1a</b>	190	570	126	188																																																				
<b>1b</b>	250	290	156	181																																																				
<b>2a</b>	76	300	12	188																																																				
<b>2b</b>	165	250	103	192																																																				
<b>3</b>	180	255	120	159																																																				
<b>4</b>	193	193	148	148																																																				
<b>L2</b>	11	36	6	9																																																				
<b>L3</b>	100	285	100	178																																																				
<b>Conc</b>	250	1500	100	250																																																				
<b>Vac</b>	100	100	59	59																																																				
<p><i>Technology interdependencies</i></p>	<p>Similarities to the single technologies photovoltaic and solar thermal installations connected to heating system</p>																																																							
<p><i>Advantages and disadvantages</i></p>	<p>[1] carried out a literature research and interviews and identified following advantages and disadvantages:</p> <p>Strength and opportunities</p> <p>Compactness and energy yields, combination of PVT with heat pump (fast growing sector in PVT applications), BIPVT (Building Integrated PVT), energy performance regulations for dwelling and renewable energy targets, aesthetics (homogenous roof)</p>																																																							

	<p>Weaknesses and barriers</p> <p>Complexity of system design and installation, difficulties in optimization, reliability, low economic profitability and high investment costs, competition with PV and solar thermal collectors, lack of testing, standards and certification, EPC calculations unclear, lack of awareness</p>
<p><i>Typical energy data and prices for PV solutions for one country</i></p>	<p>Energy and financial information can be found below.</p>
<p><i>Energy performance</i></p>	<p>A specific norm for complex testing PVT modules is not available at the moment. The PV module can be tested according to norm IEC 61215 and IEC 61730. Solar thermal collectors can be certified according to ISO 9806.</p> <p>Solar Keymark develops a methodology for PVT testing and certification [4].</p> <p>The electrical efficiency is determined at standard test conditions (STC, 1000W/m<sup>2</sup> irradiance and 25°C module temperature). The module efficiency depends on module temperature and irradiance. The efficiency for uncovered PVT collectors is often in the same range as standard ventilated PV modules. It depends on the application and the temperature level of the fluid, at low fluid temperatures the efficiency can also be higher. For covered collectors the efficiency is slightly lower due to the additional glass layer that increases reflection. Also for covered collectors higher PV temperatures occur and lead to lower PV efficiencies.</p> <p>The thermal efficiency can be determined according to ISO 9806. ISO 9806 acknowledges different methods for determining the uncovered and covered thermal yields, which include the steady state and the quasi-dynamic method. For thermal test two regimes has to be tested (open circuit, MPPT load).</p> <p>The collector curves for different types of several good quality PVT collectors are shown in following figure.</p>

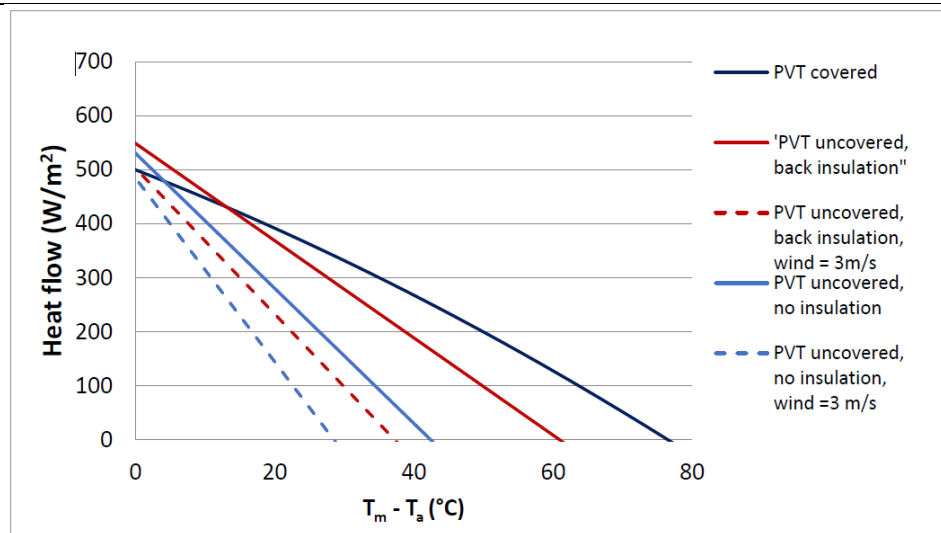

Figure 31. Typical PVT collector heat flows for covered and uncovered PVT collectors (source: [1])

*Financial data:  
investment, operation  
and maintenance*

Based on a survey prices for the module, the normalized module price (per m<sup>2</sup>) and the peak power price (per kW<sub>p</sub>) could be defined by [1].

Following figure shows the range of prices.

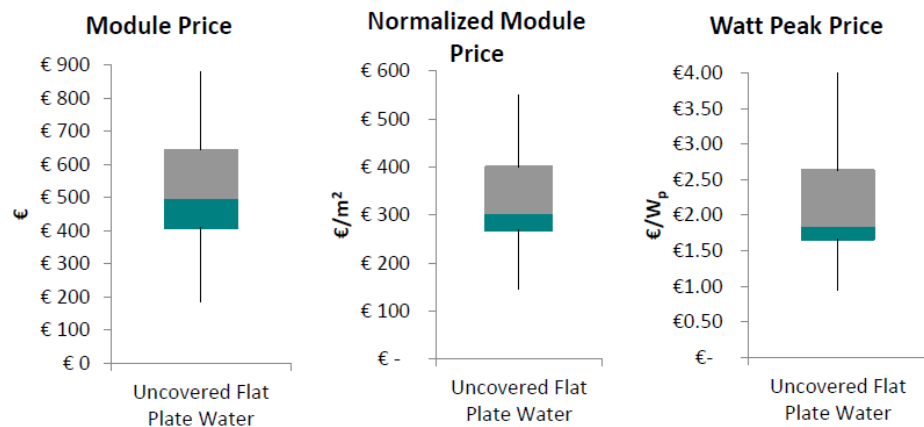

Figure 32. Range of prices for PVT modules (source: [1])

*Environmental issues*

Even if PVT seems to be a technological niche so far, the technology has environmental benefits by combining electricity and thermal energy production at the same time. On the way to a 100% renewable energy supply, PVT could play a role, as the technology can be used in both new construction and building retrofit.

*Development potential*

In addition to the existing PVT flat-plate collectors, developments go in the direction of concentrating PVT systems. Here, (high efficiency) PV cells are integrated in the receiver of a concentrating system, e.g. parabolic troughs or heliostats.

	<p>Potential for development is the application of new encapsulation materials for PV, which could withstand higher stagnation temperatures existing in glazed PVT collectors, usable for hot water applications.</p> <p>This would allow a broader possible use of the PVT technology and contribute to the expansion of the system on the market.</p> <p>Other investigations go into the direction a so-called “spectral splitting”. Here an absorption filter absorbs the short wavelengths, which have too much energy for the PV module to operate efficiently. Longer wavelengths on the other hand, whose energies just fit the band gap of the PV cells, are transmitted.</p>
<p><i>References</i></p>	<p>[1] de Keizer, Corry; Bottse, Jeffrey; de Jong, Minne (2018): PVT benchmark. An overview of PVT modules on the European market and the barriers and opportunities for the Dutch Market. Hg. v. seac.</p> <p>[2] Zennhäusern, Daniel; Bamberger, Evelyn; Baggenstos, Aleksis (2017): PVT Wrap-Up. Energy systems with photovoltaic-thermal solar collectors. Hg. v. Institut für Solartechnik SPF, HSR Hochschule für Technik Rapperswil.</p> <p>[3] Resch, Alois (2012): Implementation of Spectral Splitting in a Hybrid Concentrator Photovoltaic and Thermal Solar Collector; master thesis; University of Applied Sciences Upper Austria.</p> <p>[4] <a href="http://www.estif.org/solarkeymarknew/images/Files/190408/part2/SKN_N0444_Annex%20P5.1%20PVT_R1.pdf">http://www.estif.org/solarkeymarknew/images/Files/190408/part2/SKN_N0444_Annex%20P5.1%20PVT_R1.pdf</a></p>

### 3.3. Energy storage systems

#### 3.3.1. Thermal Energy Storage (TES)

Thermal Energy Storage (TES)	
<p><i>Description</i></p>	<p>According to Sarbu and Sebarchievici (2018) “Thermal energy storage (TES) is a technology that stocks thermal energy by heating or cooling a storage medium so that the stored energy can be used at a later time for heating and cooling applications and power generation. TES systems are used particularly in buildings and in industrial processes.”</p> <p>Thermal storages can use different principles for storing heat: sensible, latent, sorptive and chemical heat (see Figure 33). Sorptive and chemical heat storage technologies are called thermochemical energy storages. The difference between them can be briefly described as follows:</p> <ul style="list-style-type: none"> <li>• Sensible heat storage depends on the heat capacity of the storage material. Examples for sensible heat stores are water storage tanks or borehole thermal energy stores. The enthalpy-temperature curve is linear (see Figure 34).</li> <li>• Latent thermal heat storages use the phenomenon that there is a temperature range at which the material changes its phase (PCM = phase change material). This is coupled to a large increase (or vice versa decrease) in enthalpy (e.g. melting, evaporation, crystallisation). The materials used for latent thermal heat stores are organic and inorganic phase change materials.</li> <li>• Thermochemical heat storage uses the principle of physical adhesion and absorption enthalpy or chemical reaction enthalpy. Sorptive storage tanks can be operated as open or closed systems.</li> </ul> <div style="text-align: center;"> <pre> graph TD     TS[Thermal Storage] --&gt; S[Sensible]     TS --&gt; L[Latent]     TS --&gt; Sor[Sorption]     TS --&gt; CR[Chemical Reactions]          S --&gt; S_L[Liquid]     S --&gt; S_S[Solid]          S_L --&gt; W[Water]     W --&gt; A[Aquifer]          S_S --&gt; BM[Building Mass]     BM --&gt; C[Concrete]     C --&gt; G[Ground]          L --&gt; I[Inorganic]     I --&gt; SH[Salhydrates]          L --&gt; O[Organic]     O --&gt; P[Paraffins]     O --&gt; SA[Sugar Alcohols]          Sor --&gt; Ad[Adsorption]     Ad --&gt; Ad_o[open]     Ad --&gt; Ad_c[closed]          Sor --&gt; Abs[Absorption]     Abs --&gt; Abs_o[open]     Abs --&gt; Abs_c[closed]          CR --&gt; CR         </pre> </div> <p>Figure 33. Thermal Storage technologies</p> <p>The simplified storage procedure of the different methods is shown below.</p>

	<p>Figure 34. Methods of thermal energy storage: (a) sensible heat; (b) latent heat; (c) thermochemical reactions (source: (Sarbu and Sebarchievici 2018))</p>
<p><i>Main characteristics</i></p>	<p>As described above a wide variety of materials are being used for thermal energy storage. TES materials have to fulfil different requirements. On the one hand, the physical properties are important to allow efficient operation of the system and on the other hand, properties that enable safe operation of the thermal energy storage are needed (e.g. nontoxic storage material).</p> <p>An energy storage system can be described in terms of the following characteristics (see also (Sarbu and Sebarchievici 2018):</p> <ul style="list-style-type: none"> <li>• Capacity defines the energy stored in the system and depends on the storage process, the medium, and the size of the system;</li> <li>• Power defines how fast the energy stored in the system can be discharged (and charged);</li> <li>• Efficiency is the ratio of the energy provided to the user to the energy needed to charge the storage system. It accounts for the energy loss during the storage period and the charging/discharging cycle;</li> <li>• Storage period defines how long the energy is stored (i.e. hours, days, weeks, and months for seasonal storage);</li> <li>• Charge and discharge time defines how much time is needed to charge/discharge the system; and</li> <li>• Cost refers to either capacity (EUR/kWh) or power (EUR/kW) of the storage system and depends on the capital and operation costs of the storage equipment and its lifetime (i.e., the number of cycles).</li> </ul>
<p><i>Power range</i></p>	<p>The power range is summarized in Table 15 (further down in point “energy performance”).</p>
<p><i>Technology interdependencies</i></p>	<p>The combination with solar thermal collectors would be beneficial, but also other heat sources could be used, such as geothermal energy, industrial waste heat or biomass. Sensible heat storages do not place any great demands on the heat generator as long as the required temperature level is reached. This, in turn, depends on the application, e.g. domestic hot water, heating, etc.</p>



	<p>The requirements to the temperature level are also the criterion which determines the use of the different heat generators, in combination with thermochemical and latent heat storages. Since a corresponding temperature level is required here, solar thermal, waste heat or direct electricity (in combination with PV) are often used.</p> <p>For seasonal storage solar thermal and PV are the most used heat (respectively electricity) producers, which are then used in combination with thermochemical and latent heat storages.</p>																									
<i>Advantages and disadvantages</i>	<p>The use of sensible heat storage tanks is well known and was investigated extensively. More complex but promising technology is the use of phase change materials (PCM) and of thermochemical energy storages (TCM).</p> <p>TCM systems have the advantage of a higher energy storage density (6 times higher than water) leading to more compact storage systems and therefore smaller sizes of the system. A further advantage is that there are no sensible heat losses during storage time and therefore these technologies would be perfectly applicable for seasonal heat storage.</p> <p>Current disadvantages are the low experience regarding the use of PCM and TCM thermal storages and the high investment costs, especially for the energy storage material.</p>																									
<i>Typical energy data and prices for window solutions for one country</i>	Energy and financial information are included below.																									
<i>Energy performance</i>	<p>Parameters to describe the energy performance of a thermal energy storage can be the storage capacity, the power and the efficiency. Furthermore, the possible storage period can be relevant. Table 1 shows an overview of the parameters for sensible heat storages, PCM and of chemical heat storages:</p> <p>Table 15. Typical parameters of thermal energy storage systems (source: (Sarbu and Sebarchievici 2018))</p> <table border="1"> <thead> <tr> <th>TES System</th> <th>Capacity (kWh/t)</th> <th>Power (MW)</th> <th>Efficiency (%)</th> <th>Storage Period</th> </tr> </thead> <tbody> <tr> <td>Sensible (hot water)</td> <td>10-50</td> <td>0.001 - 10.0</td> <td>50-90</td> <td>days/months</td> </tr> <tr> <td>PCM</td> <td>50-150</td> <td>0.001 - 1.0</td> <td>75-90</td> <td>hours/months</td> </tr> <tr> <td>chemical reactions</td> <td>120-250</td> <td>0.01 - 1.0</td> <td>75-100</td> <td>hours/days</td> </tr> <tr> <td></td> <td></td> <td></td> <td></td> <td></td> </tr> </tbody> </table>	TES System	Capacity (kWh/t)	Power (MW)	Efficiency (%)	Storage Period	Sensible (hot water)	10-50	0.001 - 10.0	50-90	days/months	PCM	50-150	0.001 - 1.0	75-90	hours/months	chemical reactions	120-250	0.01 - 1.0	75-100	hours/days					
TES System	Capacity (kWh/t)	Power (MW)	Efficiency (%)	Storage Period																						
Sensible (hot water)	10-50	0.001 - 10.0	50-90	days/months																						
PCM	50-150	0.001 - 1.0	75-90	hours/months																						
chemical reactions	120-250	0.01 - 1.0	75-100	hours/days																						
<i>Financial data: investment, operation and maintenance</i>	Giving financial data is very difficult, especially for the more innovative storage technologies like PCM.																									

	<p>A benchmark for investment costs is 35 EUR/kWh installed capacity. Values for operation and maintenance costs are not available so far.</p>
<i>Environmental issues</i>	<p>The shift towards a completely renewable energy supply requires new storage technologies, to enable the use of fluctuating renewable energy sources all over the year. Intelligent new emerging thermal energy storage technologies, like PCM, TCM, seem to play an important part in the energy supply of tomorrow.</p>
<i>Development potential</i>	<p>A lot of research is still necessary for PCM and TCM to be ready for the (mass) market. At the moment the high initial capital cost requirement is an impediment to the implementation of TES. The continued research effort is needed to reduce cost through the use of alternative cheap TES materials from renewable bio sources, naturally occurring earth materials, industrial waste materials etc.</p> <p>Furthermore, the usage of TES is not as convenient as the usage of fossil fuel due to limitations in the current level of technology. Attributes such as higher energy storage densities, faster charging and discharging cycles, easy delivery mechanisms to end-user, lower heat losses and lower parasitic loads are desired in future TES systems.</p>
<i>References</i>	<p>[1] Alva, Guruprasad; Lin, Yaxue; Fang, Guiyin (2018): An overview of thermal energy storage systems. In: Energy 144, S. 341–378. DOI: 10.1016/j.energy.2017.12.037.</p> <p>[2] Sarbu, Ioan; Sebarchievici, Calin (2018): A Comprehensive Review of Thermal Energy Storage. In: Sustainability 10 (2), S. 191. DOI: 10.3390/su10010191.</p>

### 3.3.2. Electrical storage

<b>Electrical storage</b>	
<i>Description</i>	<p>Electricity can be stored in a number of ways. Here solid-state batteries and flow batteries are described.</p> <p><b>Solid-state batteries (SSB)</b></p> <p>On its most basic level, a battery is a device consisting of one or more electrochemical cells that convert stored chemical energy into electrical energy. Each cell contains a positive terminal, or cathode, and a negative terminal, or anode. Electrolytes allow ions to move between the electrodes and terminals, which allows current to flow out of the battery to perform work.</p> <p>Advances in technology and materials have greatly increased the reliability and output of modern battery systems, and economies of scale have dramatically reduced the associated costs.</p> <p>The most well-known type of solid-state battery is the Li-ion type – often used in electric cars. Other types are Ni-Cd- and Sodium-Sulphur (NaS) batteries. The latter has been used extensively in Japan.</p> <p><b>Flow batteries (FB)</b></p> <p>A flow battery is a type of rechargeable battery where rechargeability is provided by chemical components dissolved in liquids contained within the system and most commonly separated by a membrane. This technology is akin to both a fuel cell and a battery - where liquid energy sources are tapped to create electricity and are able to be recharged within the same system.</p> <p>Different classes of flow cells (batteries) have been developed, including redox, hybrid and membrane-less. The fundamental difference between conventional batteries and flow cells is that energy is stored as the electrode material in conventional batteries but as the <u>electrolyte</u> in flow cells. There are different types of flow batteries, i.e.: Redox, Iron-Chromium, Vanadium Redox and Zinc-Bromine based.</p>
<i>Main characteristics</i>	<p>SSB: Relatively high power in and out: Suitable for short-term – up to 6 hours - peak – shaving / electrical storage.</p> <p>FB: Allows for long term storage without losses</p>
<i>Power range</i>	<p>SSB: The size may vary from energy-type batteries of a few kilowatt hours in residential systems with rooftop photovoltaic arrays to multi-megawatt containerized batteries for the provision of grid ancillary services.</p>

	<p>FB: The size can be varied by changing the size of the storage tanks for the electrolyte. For one producer in Denmark storage capacities may vary from 25 to 500kWh. Nominal charge/discharge power may vary from 5 to 100kW.</p>
<i>Technology interdependencies</i>	<p>Synergies with heat pumps, renewable energy systems: PV and wind.</p>
<i>Advantages and disadvantages</i>	<p>SSB: The Li-ion is a rather simple construction, which is easy to install in the electrical network.</p> <p>FB: First, the flow battery is a very green/sustainable solution compared to a solid-state battery. Second, the power and energy ratings are independent of each other and each may be optimized separately for a specific application. Third, it has a long life-time of &gt;20 years and more than 10.000 cycles. Fourth, they can be almost instantly recharged by replacing the electrolyte liquid, while simultaneously recovering the spent material for re-energization.</p>
<i>Typical energy data and prices for window solutions for one country</i>	<p>Lithium ion batteries now cost around \$200 per kilowatt hour [1]:</p> <p>Flow batteries are still in an earlier phase of development and prices are higher – in the range of \$450 - \$1150 – the larger the cheaper.</p>
<i>Energy performance</i>	<p>Currently SSB has reached an energy density of 250 kWh/kg. FB has considerably less energy density.</p>
<i>Financial data: investment, operation and maintenance</i>	<p>Investment: SSB: Around 300 Euro/kWh; FB: Around 1000 Euro/m<sup>3</sup></p> <p>Operation and maintenance costs generally fixed a percentage of the investment costs.</p>
<i>Environmental issues</i>	<p>The typical issues for Lithium ion battery, e.g. <a href="https://www.wired.co.uk/article/lithium-batteries-environment-impact">https://www.wired.co.uk/article/lithium-batteries-environment-impact</a></p>
Development potential	<p>As the market for electrical energy storage is expected to grow exponentially over the coming years there is a great push for further developments towards increased cost efficiency of both battery types. <b>SSB:</b> Continued innovation has created new technologies like electrochemical capacitors that can be charged and discharged simultaneously and instantly, and provide an almost unlimited operational lifespan. Large production facilities has been and is being built and with these follows large development department that will boost the technology. <b>FB:</b> The increased demand for longer term electrical storage with almost no losses will result in an accelerated development of these batteries towards an increased price/performance ratio.</p>
<i>References</i>	<p>[1] SSB: <a href="http://energystorage.org/energy-storage/storage-technology-comparisons/solid-state-batteries">http://energystorage.org/energy-storage/storage-technology-comparisons/solid-state-batteries</a></p>

	<p>[2] FB: <a href="http://energystorage.org/energy-storage/storage-technology-comparisons/flow-batteries">http://energystorage.org/energy-storage/storage-technology-comparisons/flow-batteries</a></p> <p>[3] <a href="https://www.mckinsey.com/business-functions/sustainability/our-insights/sustainability-blog/these-9-technological-innovations-will-shape-the-sustainability-agenda-in-2019?cid=other-eml-alt-mip-mck&amp;hlkid=f2bd212bd3ad4056bc92548d77c28c21&amp;hctky=10128203&amp;hdpid=18f50e31-5c86-4c21-a796-58b2010163c0">https://www.mckinsey.com/business-functions/sustainability/our-insights/sustainability-blog/these-9-technological-innovations-will-shape-the-sustainability-agenda-in-2019?cid=other-eml-alt-mip-mck&amp;hlkid=f2bd212bd3ad4056bc92548d77c28c21&amp;hctky=10128203&amp;hdpid=18f50e31-5c86-4c21-a796-58b2010163c0</a></p>
--	---

## 4. Techno-economic characterization

Optimization process for building retrofit on the district level both with energy efficiency measures and renewable energy sources integration requires up to date data on their technical parameters and costs. The data differs from country to country due to climate and economic conditions and change over time. Therefore, a survey among Annex 75 partners has been performed to gather data on efficiency and costs for selected technologies presented in previous chapter as at 2019. Equipment sizes range from units for single-family houses to units for multifamily buildings and the district scale, in order to also evaluate the economy of scale.

### 4.1. Survey

An excel sheet template has been provided for the purpose of internal survey (2019) on parameters of technologies. Efficiency and cost data dependent on size (power, area, insulation quality, etc.) have been collected for a given technology. Regarding the completion of the survey, different approaches were assumed, taking into consideration national contexts. In addition, data provided were strictly dependent on the field of expertise of the consortium members (countries). In some cases, only a few technologies have been covered. Several technologies have been covered only by data from one country. Results depend also on application potential and experience with the technologies in given countries.

In total, feedback from 9 countries (from a total of 13 participating countries) has been gathered:

- AT (Austria)
- CZ (Czech)
- DK (Denmark)
- ES (Spain)
- NO (Norway)
- PT (Portugal)
- SE (Sweden)
- NL (Netherland)
- CH (Switzerland)

The quality of data (number of parameters filled, coverage of technologies, data consistency) is distinctive for different technologies as shown in Figure 35. Building measures technologies had the best data coverage. In case of renewable energy sources, popular PV and solar thermal applications, together with heat pumps are covered quite well, while cooling units, PVT collectors (still quite new on the market) or biomass combined heat and power (lack of experience in building integrated solutions) are covered much less.

The next chapters show some important findings from the survey and compare the results with a review made for selected technology in journals. To show dependency of annual parameters on climate, several energy analyses have been done as well.

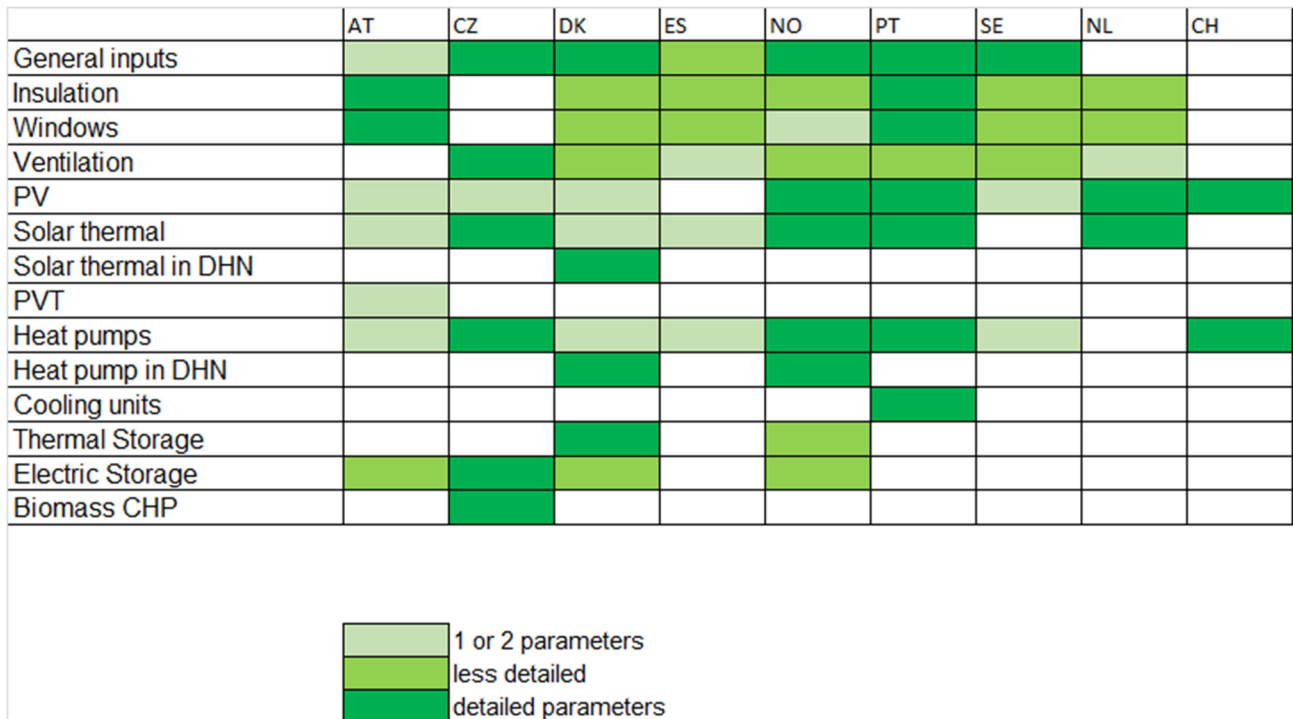

Figure 35. Quality of data from survey

## 4.2. PV systems

Photovoltaic systems are one of the most promoted measures for the decarbonisation of buildings, due to a still large CO<sub>2</sub> producing electricity generation. Presently, PV systems can be considered a mature technology with continuously decreasing investment costs. Silicon crystalline technology has the most significant share of the market, with about 85%. Figure 36 shows the specific investment costs (EUR/kW<sub>p</sub>) of the silicon crystalline PV technology dependent on size of the system as resulted from the survey complemented with data from review (bold curves) [1]. The majority of the findings are in a good mutual correlation and are consistent with a review paper. It can be seen that generally there is a visible economy of scale. Small PV systems with peak power of several kW<sub>p</sub> are about 50% more expensive than large system with tens and hundreds kW<sub>p</sub>.

Performance characterization of PV systems is dependent on climate, especially on the solar irradiation in given location. A simplified approach, which could be used in the optimization process, is presented in EN 15316-4-3 [2]. The annual electricity production [kWh/a] can be calculated as:

$$E_{\text{prod}} = 0.8 \times \eta_{\text{ref}} \times H_T \times A_{\text{PV}}$$

where is

$\eta_{ref}$  reference efficiency of given technology;

$H_T$  annual solar irradiation [kWh/m<sup>2</sup>.a];

$A_{PV}$  PV system area [m<sup>2</sup>].

This approach assumes free-standing PV modules, moderate temperature influence on efficiency and conventional system based on DC wiring, DC-AC inverter with MPPT and AC wiring, without use of electric storage (larger losses).

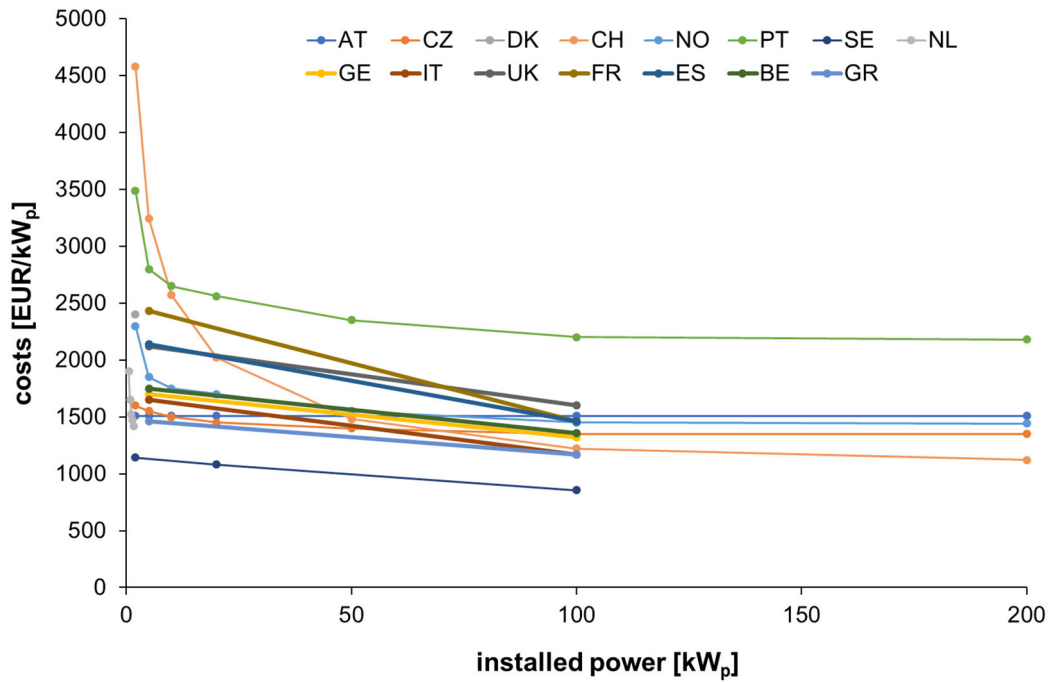

Figure 36. PV system specific costs dependent on size (crystalline technology) per country



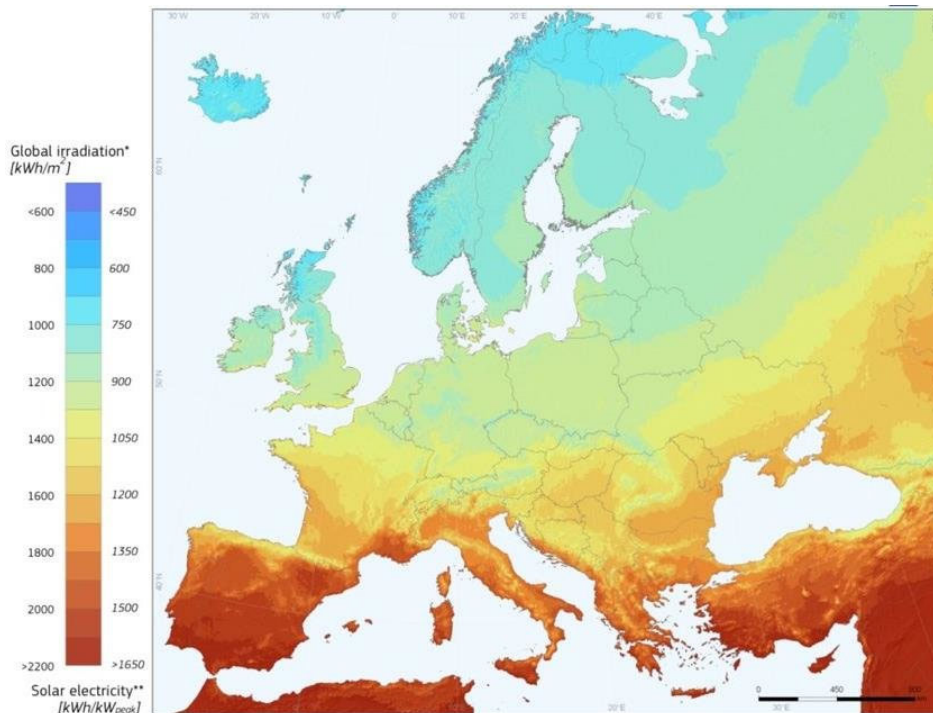

Figure 37. Solar irradiation and specific PV system electricity production in different locations [5]

Realistic energy balance to obtain the final usability of PV electricity production is much more complex, especially when considering the applications without electric storage. The mismatch between the electricity production and electricity load in buildings during the day and during the year degrades the real performance figures (performance characteristics). Figure 38 shows the results of the analysis for about 500 cases of different load profiles in households (domestic appliances only) and different sizing of PV system. The ratio between annual PV production and electricity demand directly influences the solar fraction (coverage of electric load by PV power in building). The presented diagram has been developed with use of hourly time step (both for production and load). There is a large difference between the cases with people out of the household during the day and cases with people in the household during the day.

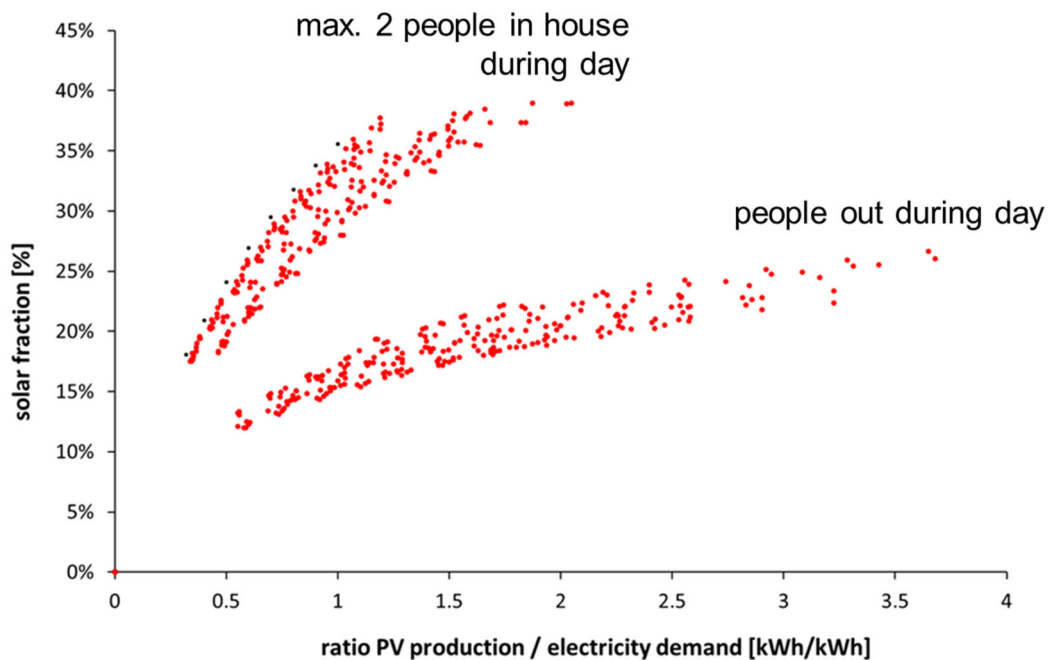

Figure 38. Diagram of solar fraction based on annual figures of PV production and electricity demand (IEA Annex 75 – to be published).

The cases with use of electrically driven heat pumps - electric heating, in addition to the appliances can result in different diagrams.

### 4.3. Solar thermal

Solar thermal systems are a renewable energy technology for heat production, mainly for the purpose of hot water and space heating (small, large scale). Similar to PV systems, solar thermal system can be considered a mature technology, but without expectation of radical decrease of cost in the future. While the European market is dominated by flat-plate collector technology, the world market driven by China is dominated by evacuated tube collectors. Figure 39 shows the specific investment costs (EUR/m<sup>2</sup>) of solar thermal systems based on the flat-plate collector technology dependent on size of system. Vacuum tube systems cost about 20 to 30% more. The data and trends in costs are very similar and can be regarded as reliable.

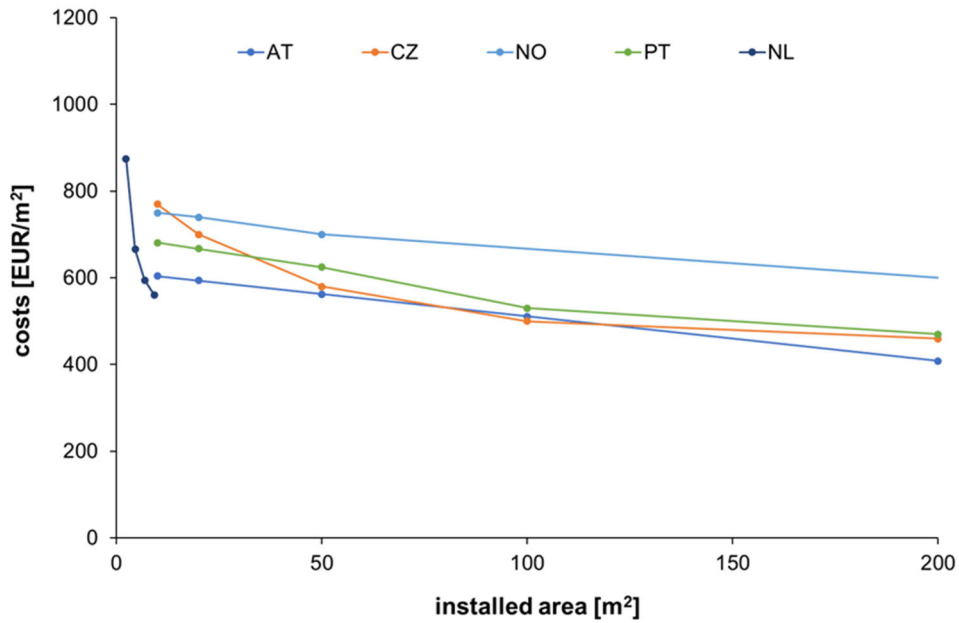

Figure 39. Solar thermal system specific costs dependent on size (flat-plate technology) per country

Solar thermal systems practically always include storage system and the performance characterization includes the possibility to store the heat for later use by heat load of the buildings. The performance of solar collectors is dependent on climate (solar irradiation, ambient air temperature) and system operation temperature (heat transfer liquid temperature).

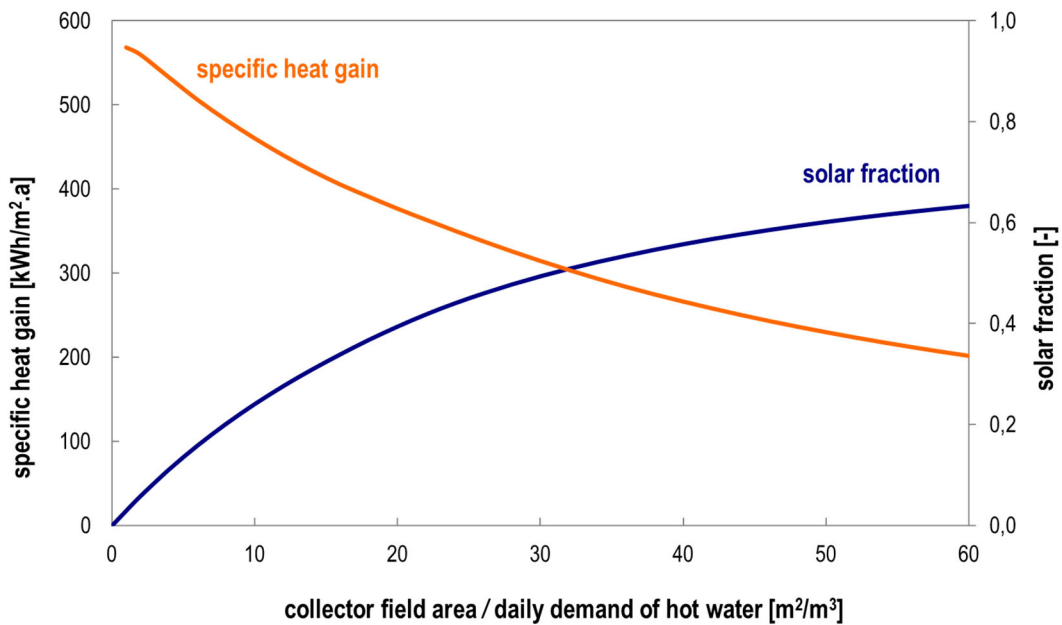

Figure 40. Solar thermal system specific costs dependent on size (flat-plate technology). (Tomas Matuska – not published).

System operation temperature is not given only by application (hot water, space heating, district heating), but also by sizing of the system. System oversizing with respect to a given heat load, results

in higher operation temperature, and a larger part of possible heat gains is lost without use (excess heat gains) as well (see Figure 40). Operation temperature has a direct influence on thermal losses of the system (piping, storage) which further decrease efficiency. Generally, larger system (larger collector area) results in lower share of heat loss on heat produced by solar collectors, thus it results in higher efficiency, i.e. higher specific used heat gains in kWh/m<sup>2</sup>.a. Figure 41 presents the typical specific used heat gains of solar thermal system for hot water preparation with different sizes. In short, larger systems are more efficient but oversizing can lead to losses due to inefficiency.

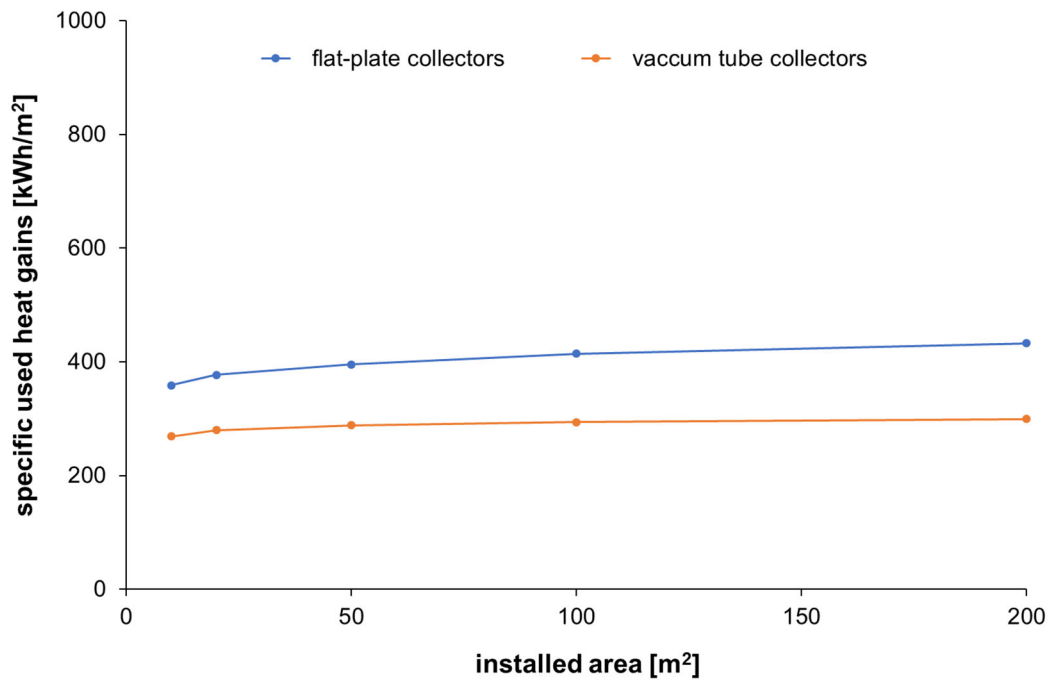

Figure 41. Solar thermal system specific heat gains dependent on size (IEA Annex 75 survey)

#### 4.4. Heat pumps

Performance and costs characterization has been focused only to electrically driven heat pumps, both air-source and ground source heat pumps, which have highest potential for integration into buildings or district heating networks. Heat pump performance significantly depends on operation temperatures both at heat extraction side (heat source: air, ground, water) and at heat load side (heating system, hot water preparation).

Figure 42 and Figure 43 respectively show the specific investment costs (EUR/kW) of the air source heat pump and ground source heat pump installation, dependent on the size of the system as resulted from the survey complemented with data from review (bold curves) [3]. While cost data for air source heat pumps seems similar for most of country sources (Figure 42), the cost data for ground source heat pumps are much more distinctive and future refinement has to be done in connection with case studies.

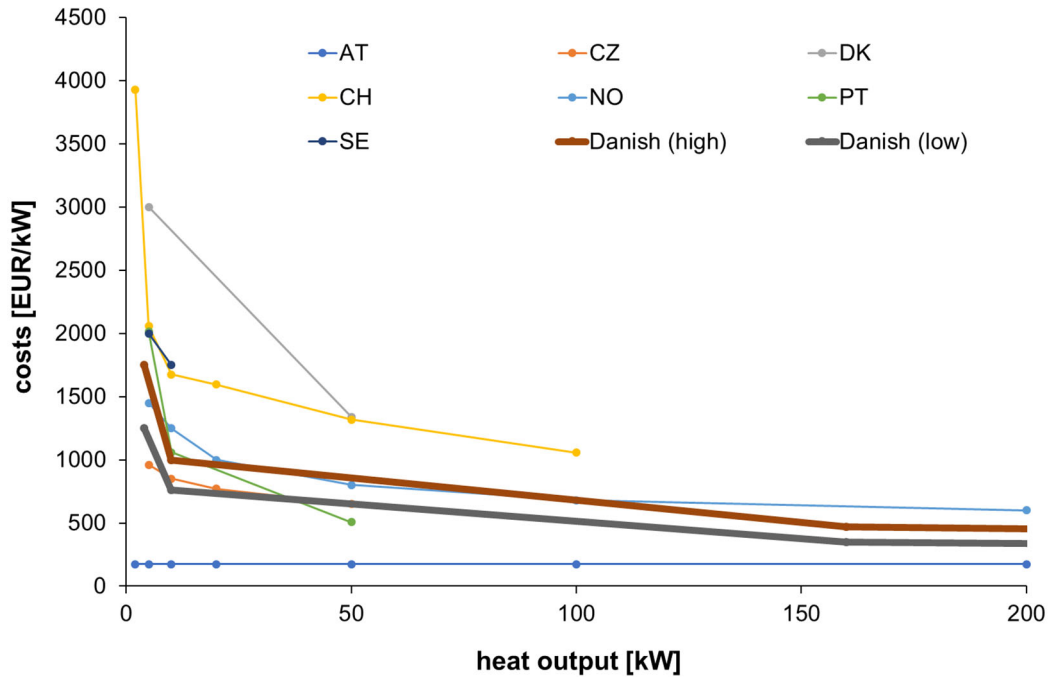

Figure 42. Air source heat pump specific costs dependent on size (heat output) per country

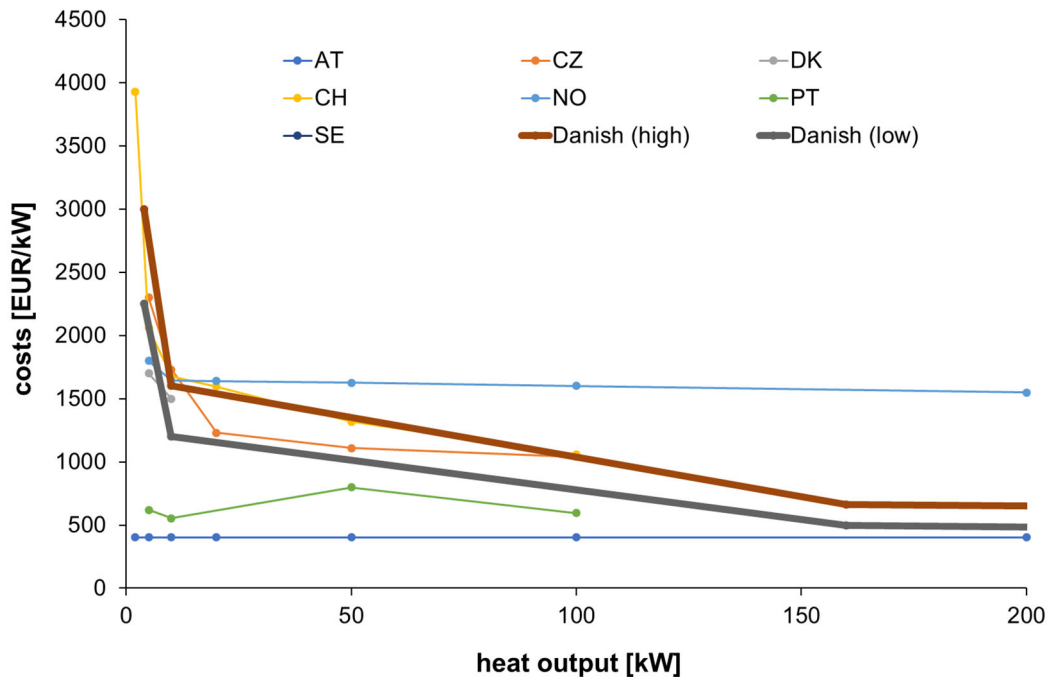

Figure 43. Ground source heat pump specific costs dependent on size (heat output) per country

When characterizing heat pump systems, seasonal performance factor (SPF) or seasonal coefficient of performance (SCOP) is used, including the back-up electricity and pumping work in balance. Figure 44 shows the dependency of SCOP (declared for heat pump energy certificates) for air source heat pumps on heat output and the difference between variable speed compressor technology and conventional fixed speed compressor. Variable speed compressor heat pumps with continuous heat

output control are getting higher and higher share on the market, especially because possibility of easy cooperation with PV systems.

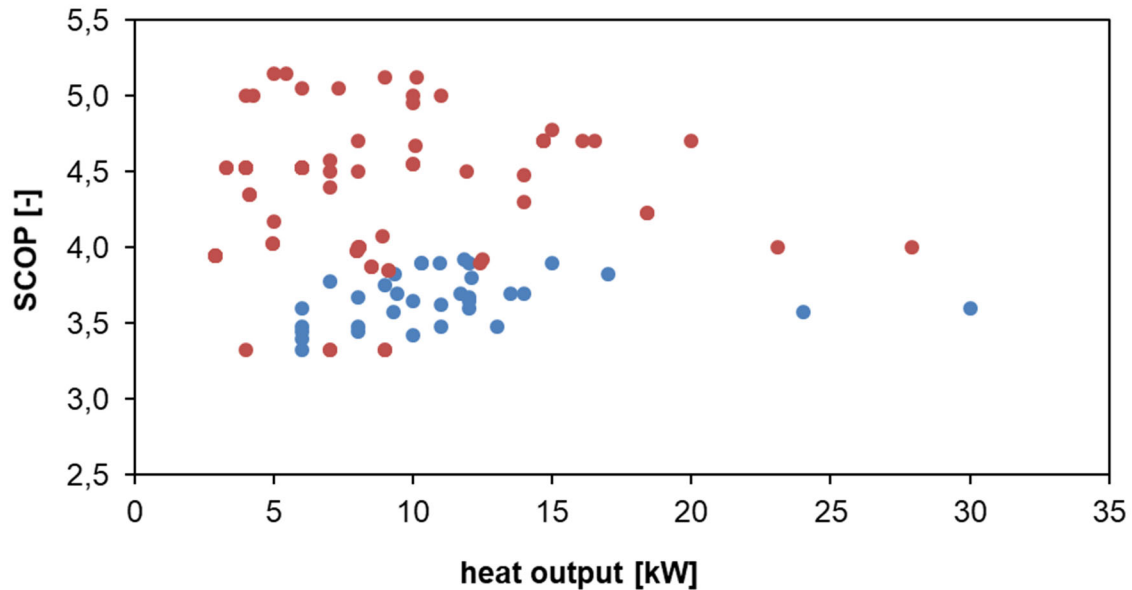

Figure 44. Seasonal COP for air-source heat pumps for low temperature application (red: variable speed compressor; blue: fixed speed compressor), moderate climate (result from CZ survey within IEA Annex 75 – limited amount of data available – especially for large heat pumps)

Data from Figure 44 are for space heating application with nominal temperature of heating water 35 °C and thus can be regarded as most optimistic limit in efficiency. Ten years of monitoring of heat pump installations in buildings under real operation conditions show a different picture, especially if domestic water heating takes part. Figure 45 shows the results from three monitoring campaigns in Germany [4]. Average seasonal performance factors SPF of heat pump systems are around 4.0 for ground source and around 3.0 for air source technology. (SPF is more universal than SCOP. It can be calculated by EN 15316-4-2 for given heat pump/building system, but also be assessed from monitored data from installations).

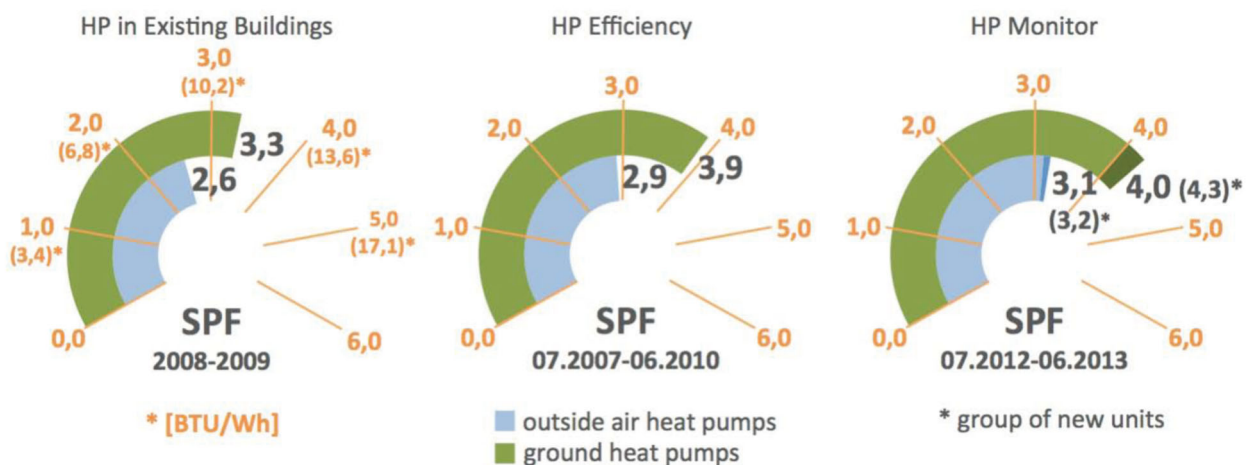

Figure 45. SPF for monitored heat pump systems [4].

When considering the operation of heat pumps in buildings in an optimization process, space heating mode and hot water preparation mode have to be calculated separately. While operation for space heating can achieve high values of SPF due to low temperature heating system, hot water preparation to hygienic temperature standard of 55 °C results in SPF values ranging around 2,5, without distinction between ground source or air source heat pumps. Table 16 shows the case of air source heat pump installation for retrofitted multi-family house (CZ climate) with original heat loss of 151 kW and heating system of 80/60 °C. Different energy efficient measures for building envelope and installation of ventilation with heat recovery can significantly reduce space heating demand while hot water demand remains the same. While SPF of the considered air source heat pump increases with better energy efficient measures due to lowering nominal heating water temperature,  $SPF_{tot}$  for total heat pump operation including hot water preparation with  $SPF = 5$  does not suffer any change. The reason is the increasing dominance of heat demand for hot water system (and importance of effectivity of heat pump for hot water preparation) with decrease of space heating demand - less importance of the seasonal performance for space heating factor ( $SPF_{SH}$ ).

Table 16. Seasonal performance factors for retrofit of multifamily house (IEA Annex 75 analysis).

Retrofit case	Heat load [kW]	Specific SH demand [kWh/m <sup>2</sup> ]	System temperatures [°C]	$SPF_{SH}$ [-]	$SPF_{tot}$ [-]
Original building	151	111	80/60	-	-
Required U-values	82	35	57/46	2,8	2,6
Recommended U-values	74	28	54/44	2,9	2,7
Recommended U-values + HR vent	55	18	47/40	3,1	2,7
Passive house standard	40	10	40/35	3,4	2,7

## 4.5. Conclusion

The survey on techno-economic characterization of selected measures for retrofit of buildings has shown general lack of data especially for specific renewable energy sources, e.g. biomass combined heat and power. There is also a general lack of data on district heating applications. Except Denmark, there is no real experience with installation of such technology as standard measure in large scale district applications. This should be further investigated in future, based on realized systems.

Another question is the reliability of cost data, which in some cases differ from country to country (heat pumps), but in other cases appears to indicate quite a good agreement (solar thermal, PV). The database of cost data should be further updated especially in connection with case studies, where realistic data from a given region would be used for optimization process.

The performance characterization is another topic. Several preliminary analyses have been made to show possible complications (and possible simplifications) in calculation process within optimization. Main renewable energy systems (solar thermal, photovoltaics, heat pumps) are significantly

dependent on climate conditions and operation conditions (load profile, load temperature). This could generally make the calculations of energy benefits for such energy systems complicated and use of simulation tools with hourly time step can be demanded for reliable results. The analyses presented here have shown that certain simplifications could be done even for simple tools e.g. from the suggested simplified evaluation of realistic used energy from PV systems or SPF of heat pumps for given building energy performance. But in case of more complicated systems, such PV and heat pump system, more analyses have to be done to prove the possible simplification for optimization tools.

## 4.6. References

- [1] Honrubia-Escribano, A. et al, (2018). Influence of solar technology in the economic performance of PV power plants in Europe. A comprehensive analysis. *Renewable and Sustainable Energy Reviews* 82 (2018) 488–501.
- [2] EN 15316-4-3:2017 Energy performance of buildings. Method for calculation of system energy requirements and system efficiencies. Heat generation systems, thermal solar and photovoltaic systems, Module M3-8-3, M8-8-3, M11-8-3, CEN 2017.
- [3] Pezzuto, S. et al, (2019). D2.3 WP2 Report – Open Data Set for the EU28, Hotmaps – Heating and Cooling Open Source Tool for Mapping and Planning of Energy Systems, <http://www.hotmaps-project.eu>
- [4] Miara, M. et al. (2014). Real Operating Conditions – Results of three Monitoring Campaigns in Germany, *REHVA Journal* – September 2014, pp. 7-12.
- [5] Photovoltaic Geographical Information System (PVGIS), <https://ec.europa.eu/jrc/en/pvgis>



# 5. Interdependencies, obstacles, and success factors

## 5.1. Global approach to interdependencies, obstacles, and success factors

To identify and analyse the interdependencies, obstacles and success factors to achieve the objective of intervening in buildings and districts in such a way that renovated net zero energy clusters & districts are achieved, it is very important to start from a holistic approach. A holistic approach allows to know in a global and systemic way the map of processes and the flow diagram of all the phases of the process, agents and stakeholders involved, and that the main key drivers must support successful operations of renovated net zero energy districts.

Although the work developed in this document will be limited exclusively to the technical aspects, it is important to have a global vision of all the factors which contribute to the success of the operation, and which allow the importance of the technical factors to be relativized, and to limit their true dimension.

If all the agents, stakeholders, phases, key drivers are conceptualized to achieve a successful intervention of renovated net zero energy clusters & districts, a map similar to the one presented in Figure 46, can be obtained.

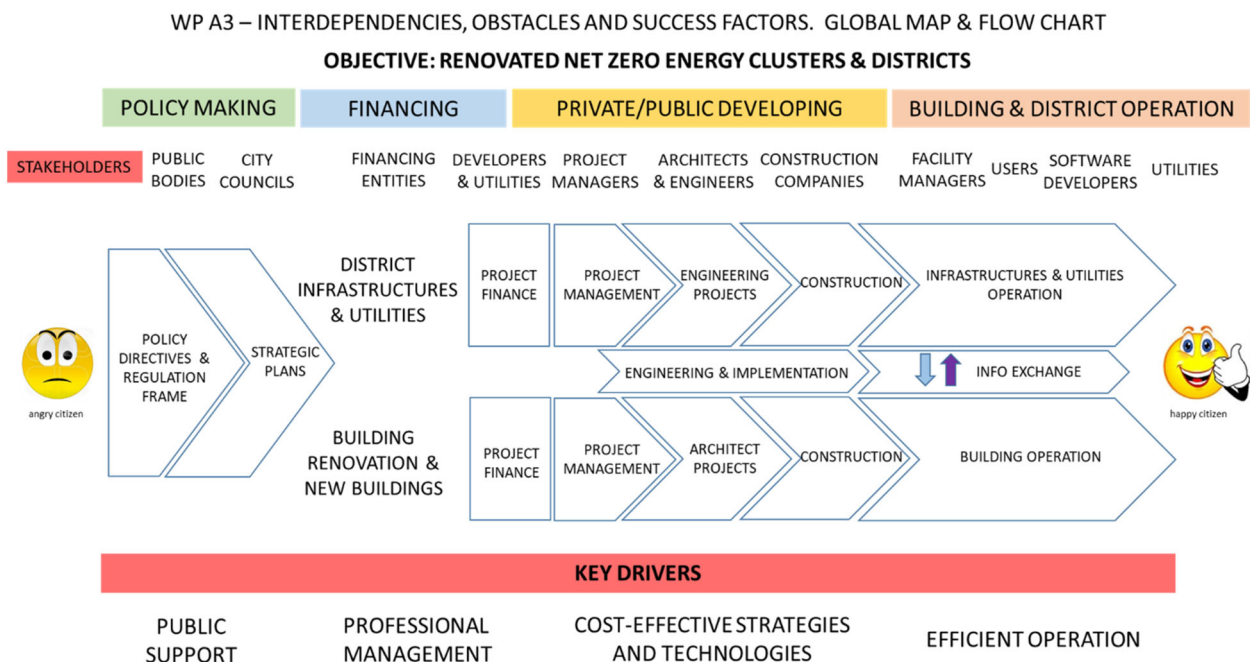

Figure 46. Map of agents, stakeholders, and phases etc. for achieving a successful intervention.

Accordingly, it is very clear that the interdependencies, obstacles and success factors must consider concrete strategies on how to plan the different phases, or how to manage different stakeholders and agents, paying special attention to the key drivers necessary for a successful operation. Further on, the role of the different stakeholders and how to plan a renovation intervention of buildings at the district level in an efficient and successful way will be analysed in a more detailed way.

In this chapter those aspects related to strategies and cost-effective technologies, both at the building level and at neighbourhood level, from a technical point of view, will be analysed by identifying the interdependencies, obstacles and success factors of each of the technologies identified as most promising.

The topics more oriented to the technical management of engineering projects and the construction of public infrastructure and utilities, as well as projects for the energy renovation of buildings, and their construction, will also be studied later on. Aspects related to the implementation of information exchange systems between buildings and districts, and systems for levelling demand and efficient energy management, as well as the operation of buildings from an energy point of view (BEMS), and the operation of public infrastructures and utilities (Supervisory Control And Data Acquisition - SCADAS), will not be developed in this Annex 75, except in an overall and general manner.

## **5.2. Technical interdependencies, obstacles, and success factors**

It is important to understand that, in this global and systemic approach from the technical point of view, many aspects associated with the aforementioned map must be included. In the present analysis the more organisational and project management aspects (of buildings and infrastructures), the implementation of works and their technical management, and the aspects related to the subsequent buildings and public infrastructures and utilities operation throughout their lifecycle, including the necessary exchanges of key information for efficient energy management, are left aside.

For the analysis carried out in this Task, it is necessary to think of the three different large levels at which to move (see figure 47):

### **1. Building Level**

On the one hand, the level of interventions in each of the buildings, in which it is necessary to think about what strategies should be incorporated into the building to save energy, improve the efficiency of the systems and their installations, and how to incorporate energy from renewable sources for the energy needed to implement an effective Demand side Management (see [1] and [2]). It is important to identify and analyse the different active and passive cost-effective strategies for improving energy efficiency and sustainability, as well as strategies for integrating photovoltaic solar energy, thermal solar energy, etc. It will be necessary to identify the different technical and material solutions for each of the

construction systems: insulating materials, window quality, roof top modules, improved use of thermal inertia, use of PCM, etc. (see [3], [4] and [5]).

## 2. District Level

On the other hand, it will be desirable to consider those interventions that are planned at the neighbourhood or district level, identifying the public district infrastructures, the neighbourhood infrastructures of the different utilities, and the passive strategies (shading, vegetation to reduce the heat island effect, dominant wind channelling, water management, etc.), and active ones that can be applied, such as district heating infrastructures, district cooling, geothermal networks, the distributed generation of renewable energy resources in energy distribution networks which requires energy management at a district scale, thus enabling opportunities for the integration of energy supply and end use(see [6] and [7]).

## 3. Information management and Exchange

And finally a third level, that is beginning to emerge as equally essential in achieving renovated net zero energy clusters & districts, is the identification of information, key indicators, and Key Performance Indicators (KPIs) [8], necessary to improve the overall efficiency of the system from the exchange of information between different buildings, and between buildings and public grids and utility infrastructures. The use of information and communication technologies (ICTs) means that it is feasible to manage energy not only in an individual building, but also on a district scale. However, it also generates a considerable amount of energy management (EM) data [9]. In that sense, it is worth to mention tools such as GIS (Geographic Information Systems), SCADAS (Supervisory Control And Data Acquisition), at district level, as well as tools at building level such as CAFM (Computer Aided Facility Management), IWMS (Integrated Workplace Management Systems), BMS (Building Management Systems), BEMS (Building Energy Management Systems), etc. They are becoming key factors for efficient energy management at both the building and the district level.

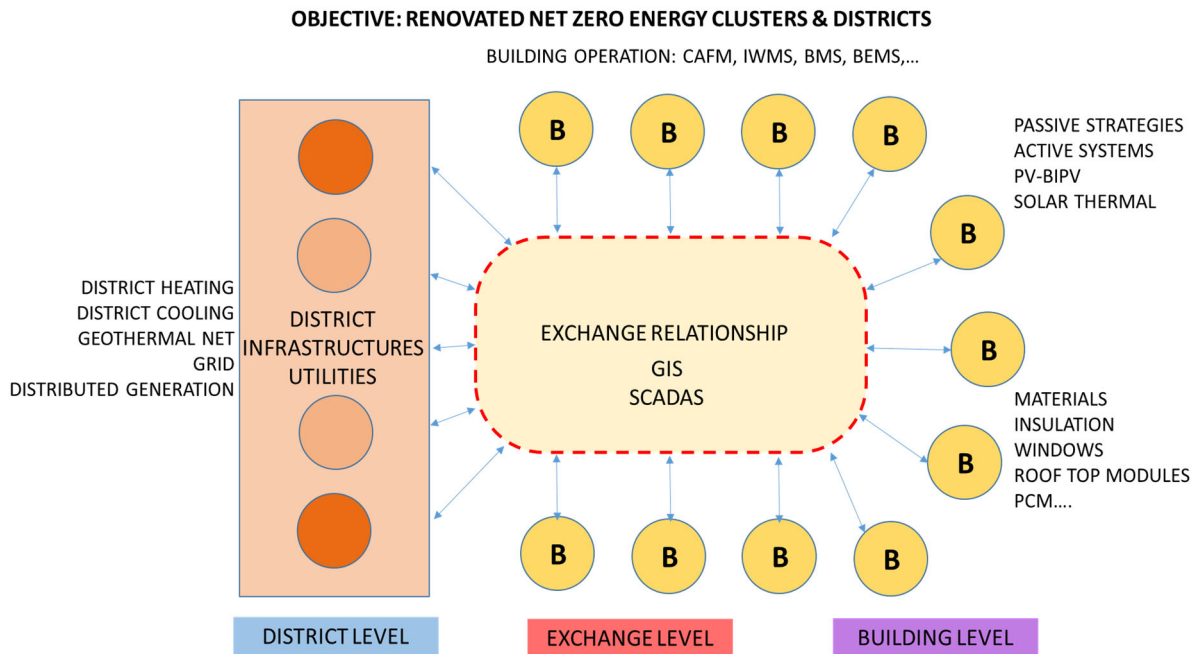

Figure 47. Interrelationships between district network and buildings.

From a practical point of view, the approach that will be taken to determine the interdependencies, obstacles and success factors for successfully renovated net zero energy clusters and districts, focuses on analysing the cost-effectiveness of the strategies conceptually, (active and passive) technologies, building systems, and materials that are considered the most promising of the various possible combinations of technologies applicable to buildings and infrastructure at the district level.

In this sense, it has been decided to focus the analysis effort on the main technologies and strategies identified as the most promising and which have been developed in other previous tasks of this Annex 75.

### 5.3. Interdependencies Factsheet definition

#### 5.3.1. Interdependencies Factsheet template

In order to systematize the analysis of the interdependencies, obstacles, and success factors of the most promising strategies, technologies, and materials, identified as Cost-effective technologies for Building Renovation at the District Level Combining Energy Efficiency & Renewables, it was decided to work with a system of factsheets that have been developed according to a reference template. In order to generate this reference template for interdependencies factsheets, the following general criteria have been considered:

The information gathered and analysed must be complementary to the descriptions of the technologies identified as most promising in the WPA1 and WPA2 work packages. Therefore,

the description of these technologies is not included in the interdependencies factsheets, but complementary information to them.

The information provided by the factsheets must be conceptually useful, both for professionals and for the scientific community, bearing in mind that the social awareness and technical knowledge of these professionals is not homogeneous. It must be understood by everyone. For this information to be useful, it must provide qualitative criteria on the Cost-effectiveness assessment. It must necessarily be a qualitative analysis, since it is not possible to carry out representative quantitative analyses (each case is unique and cost and technology change over time).

For the analysis of the interdependencies between the different strategies and cost-effective technologies, multiple aspects must be taken into account, such as which type of buildings are suitable, for which type of climate, combinations of technologies and strategies that could be interesting and complementary with that analysed, the main obstacles and associated barriers, advantages of these technologies, success factors, etc.

In order to carry out the analysis, the criterion of hierarchy in the cost-benefit ratio of the different types of strategies with which we can undertake the energy retrofitting of buildings at the district level was taken into account. This involves: prioritising strategies and technologies aimed at energy saving in the first place; improving the energy efficiency of the different construction systems, technologies, installations and equipment of buildings and infrastructures, obtaining better performance at a lower energy cost in the second place; and finally, to obtain the energy that is needed for the normal operation of the buildings, from renewable energy sources, preferably nearby. All of this must be accompanied by the necessary building operation and energy management systems (CAFM, IWMS, BEMS, SCADAs) that make it possible to level the demand and optimise the energy efficiency from the exchange of information and energy between the different buildings and the district infrastructures (Figure 48).

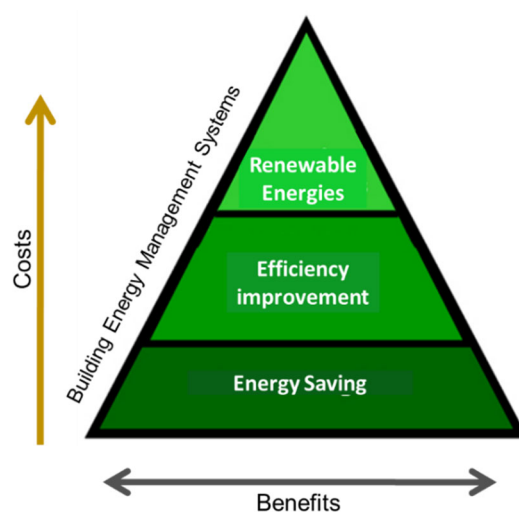

Figure 48. Cost/benefit hierarchy of energy retrofitting strategies for buildings at district level.

Another important approach for the analysis to be carried out through the factsheets is the criteria to be used for the Qualitative Cost-effectiveness assessment. For this purpose, the methodology developed by the Commission Delegated Regulation (EU) N° 244/2012 of 16 January 2012, supplementing Directive 2010/31/EU of the European Parliament and of the Council on the energy performance of buildings by establishing a comparative methodology framework for calculating cost-optimal levels of minimum energy performance requirements for buildings and building elements (Figure 49).

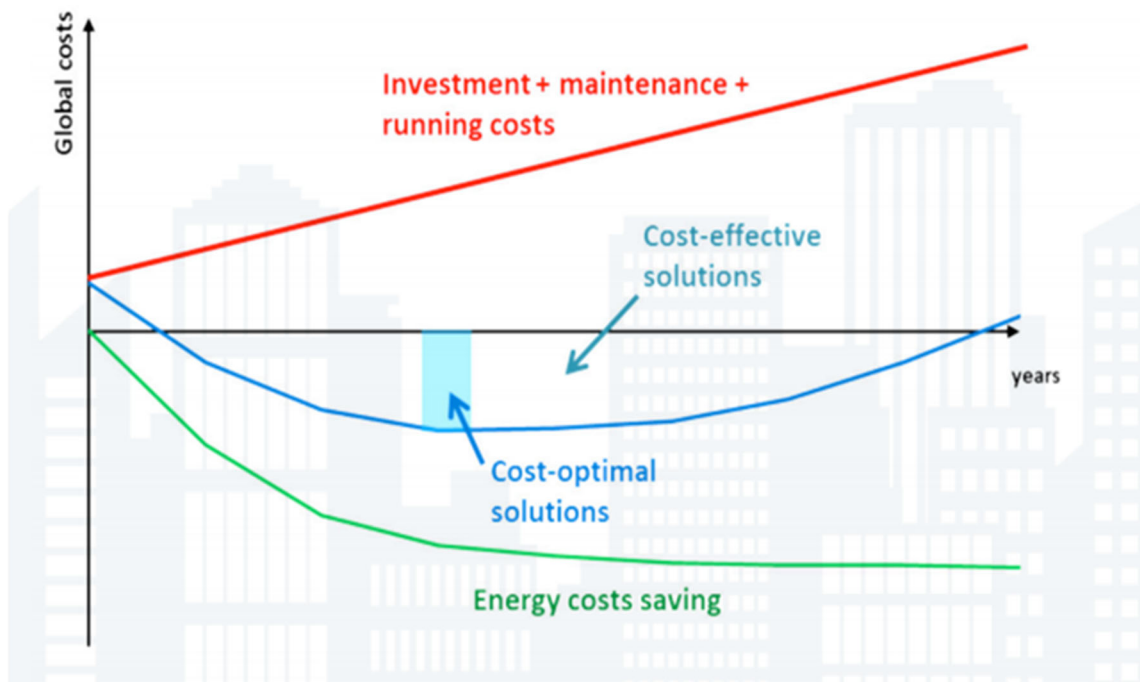

Figure 49. Comparative methodology framework for calculating cost-optimal levels.

This methodology is intended for the analysis of different strategies and alternative technologies of the same building, to determine the optimal cost solution, or a combination of technical solutions and optimal strategies, taking into account the overall economic balance achieved over the years, determining the cost-effectiveness of the solution or combination analysed. The initial investment for the energy retrofitting, plus the necessary costs of maintenance and operation, are contrasted with the savings in the energy costs that would be produced in an accumulated way over time, determining the balance of investments, expenses, and savings. On Figure 49 the blue line is the result of the sum of the red line and the green line. The minimum point of the blue line is the cost-optimal solution and all points on the blue line below the “no energy investment line (the black line) are cost-effective. This analysis doesn’t include the public benefits of emissions savings.

As the study of each technology or strategy cannot be quantitative in any case, since it is not a specific building on which to model and calculate the necessary investments specifically, their consumption and maintenance costs, and quantify the energy savings produced by them, it has had to be analysed in general qualitative terms. Qualitative analysis is produced by analysing the cost estimate in terms of strategy or technology implementation, maintenance costs, and operating

consumption, qualitatively, as well as the effectiveness in terms of energy savings, improved energy efficiency of the equipment or system, or efficiency in the generation, storage and transformation of renewable energies, both for internal consumption on-site and for export to the grid or other buildings. In addition, it describes the type of strategy or technology consists of, in which climatic conditions they can be particularly interesting, and on which factors the effectiveness of the strategy, technology, or material analysed depend.

### 5.3.2. Content definition

The interdependencies factsheet template image is presented in Figure 50.

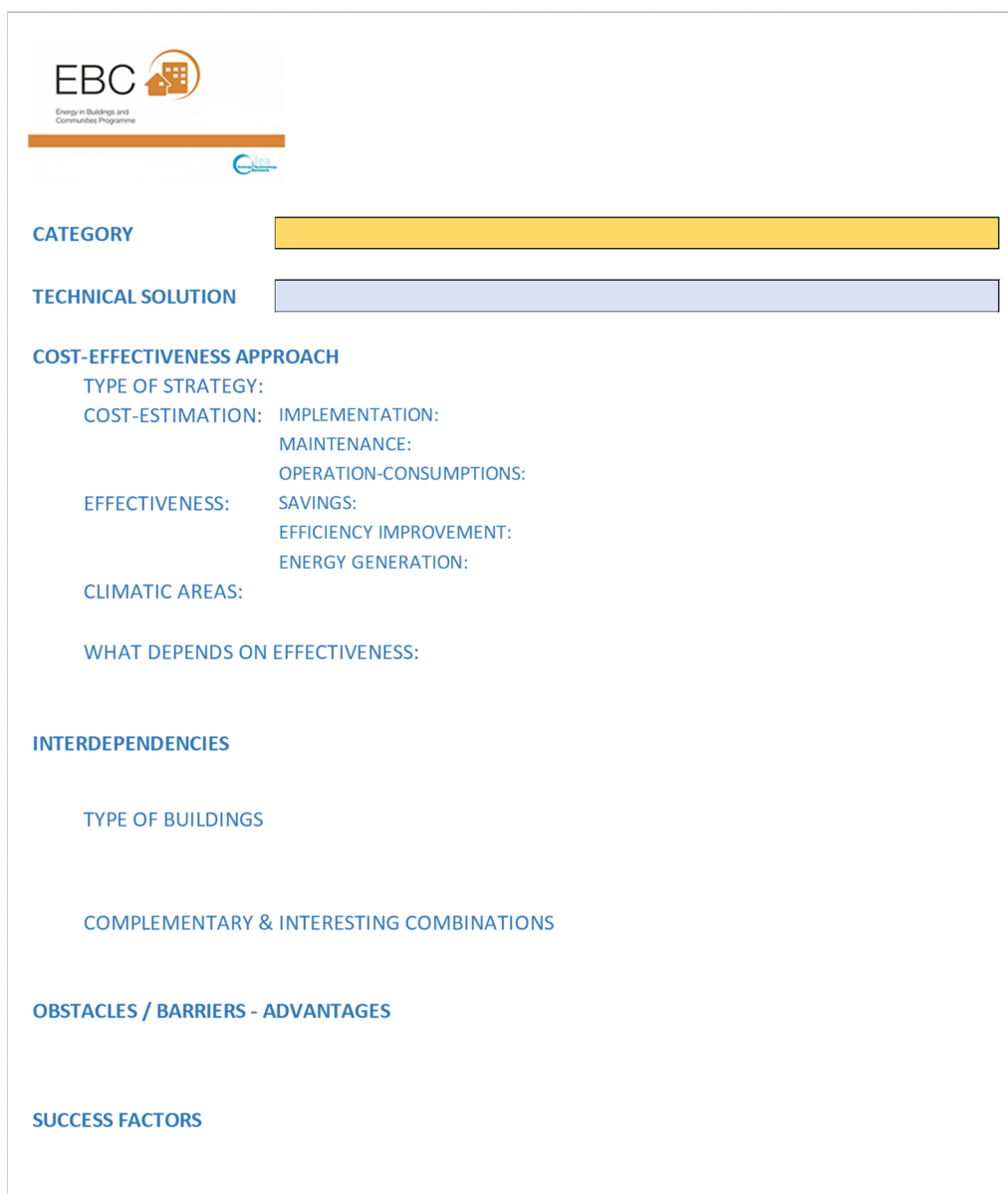

The figure shows a template for an 'Interdependencies fact sheet'. At the top left is the EBC logo (Energy in Buildings and Communities Programme) and a smaller logo below it. The form is divided into several sections, each with a label and a corresponding input area:

- CATEGORY**: A yellow rectangular input field.
- TECHNICAL SOLUTION**: A light blue rectangular input field.
- COST-EFFECTIVENESS APPROACH**: A section containing several sub-labels for data entry:
  - TYPE OF STRATEGY:
  - COST-ESTIMATION:
  - IMPLEMENTATION:
  - MAINTENANCE:
  - OPERATION-CONSUMPTIONS:
  - EFFECTIVENESS:
  - SAVINGS:
  - EFFICIENCY IMPROVEMENT:
  - ENERGY GENERATION:
  - CLIMATIC AREAS:
  - WHAT DEPENDS ON EFFECTIVENESS:
- INTERDEPENDENCIES**: A section containing:
  - TYPE OF BUILDINGS
  - COMPLEMENTARY & INTERESTING COMBINATIONS
- OBSTACLES / BARRIERS - ADVANTAGES**: A section for text entry.
- SUCCESS FACTORS**: A section for text entry.

Figure 50. Interdependencies fact sheet.

The content is organized as title and category, and four main areas related to the cost-effectiveness approach, interdependencies, obstacles / barriers – advantages, and success factors. The content includes the following information fields:

**CATEGORY:** For the possible classification of technologies, but they have not been used as such in the end since they have been applied only to the most promising technologies and strategies.

**TECHNICAL SOLUTION:** With the title that describes the strategy, material, or technology.

**COST-EFFECTIVENESS APPROACH:** With five main fields:

**TYPE OF STRATEGY:** Focusing attention on whether the strategy is active or passive, and with a minimum description of the technology, strategy, or material under analysis.

**COST-ESTIMATION:** Analysing the qualitative magnitude of the costs due to:

**IMPLEMENTATION:** Of the strategy, technology, or materials in the buildings or in the public infrastructure, or utility Grids.

**MAINTENANCE:** Qualitative assessment of maintenance costs.

**OPERATION-CONSUMPTIONS:** Qualitatively estimating running costs for operation and consumption

**EFFECTIVENESS:** qualifying the effectiveness of the technology with respect to the following possible strategies:

**SAVINGS:** How efficient it is from an energy saving point of view.

**EFFICIENCY IMPROVEMENT:** How efficient it is from an efficiency improvement point of view.

**ENERGY GENERATION:** How efficient it is for the production, storage, transformation, renewable energies, both for internal consumption on-site, and for export to the grid or other buildings.

**CLIMATIC AREAS:** In which areas or climatic conditions the technology could be more efficient and cost-effective.

**WHAT EFFECTIVENESS DEPENDS ON:** the factors or variables a greater or lesser cost-effectiveness depends are analysed at this point.

**INTERDEPENDENCIES:** With two main fields:

**TYPE OF BUILDINGS:** Defining in which types of buildings the strategies or technologies analysed could make more sense or be more cost-effective.

**COMPLEMENTARY & INTERESTING COMBINATIONS:** Identifying with which other strategies, technologies, or materials, the technology under analysis could have synergies, complementarities, or interesting combinations that would improve its cost-effectiveness.

**OBSTACLES / BARRIERS – ADVANTAGES:** Identifying the main barriers and obstacles that the technology or strategy under analysis may encounter for its implementation, as well as highlighting the possible particular advantages that they could offer.



**SUCCESS FACTORS:** Identifying the possible key drivers that could lead to a successful operation with the implementation of these strategies, technologies, or materials.

## 5.4. Datasheets on interdependencies, obstacles and success factors

Datasheets on interdependencies, obstacles and success factors can be found in Appendix I.

## 5.5. References

- [1] C.W. Gellings, Evolving practice of demand-side management, *J. Mod. Power Syst. Clean Energy* 5 (2017) 1–9, <http://dx.doi.org/10.1007/s40565-016-0252-1>.
- [2] S. Karnouskos, Demand Side Management via prosumer interactions in a smart city energy marketplace, *IEEE PES Innov. Smart Grid Technol. Conf. Eur.* (2011) 1–7, <http://dx.doi.org/10.1109/ISGTEurope.2011.6162818>.
- [3] Edwin Rodriguez-Ubinas, Letzai Ruiz-Valero, Sergio Vega, Javier Neila «Applications of Phase Change Material in highly energy-efficient houses». *Energy and Buildings* 50 (2012) 49–62. DOI: 10.1016/j.enbuild.2012.03.018
- [4] Kuznik F, Virgone J, Johannes K. «In-situ study of thermal comfort enhancement in a renovated building equipped with phase change material wallboard. *Renewable Energy* 36, pp. 1458-1462, 2011
- [5] Zhu L, Hurt R, Correia D, Boehm R. Detailed energy saving performance analyses on thermal mass walls demonstrated in a zero energy house. *Energy and Buildings*, 41(3), pp. 303-310, 2009.
- [6] M. Manfren, P. Caputo, G. Costa, «Paradigm shift in urban energy systems through distributed generation: methods and models», *Appl. Energy* 88 (2011) 1032–1048, <http://dx.doi.org/10.1016/j.apenergy.2010.10.018>.
- [7] S. Lee, B. Kwon, S. Lee, S. Member, «Joint energy management system of electric supply and demand in houses and buildings», *IEEE Trans. Power Syst.* 29 (2014) 2804–2812.
- [8] Yehong Li, James O'Donnell, Raúl García-Castro, Sergio Vega. «Identifying stakeholders and key performance indicators for district and building energy performance analysis». *Energy and Buildings* 155 (2017) 1–15. <http://dx.doi.org/10.1016/j.enbuild.2017.09.003>
- [9] Li Yehong, Raúl García-Castro, Nandana Mihindukulasooriyab, James O'Donnell, Sergio Vega. «Enhancing energy management at district and building levels via an EM-KPI ontology». *Automation in Construction*, Volume 99, March 2019, Pages 152-167. <https://doi.org/10.1016/j.autcon.2018.12.010>

## 6. Potentials and future developments

The technology options are put into context with available potentials, and an outlook is made on their future developments. The technologies covered are: windows, prefabricated facades, photovoltaics, building automation systems, low-temperature thermal grids, ground-source heat pumps, solar thermal, thermal storage, electrical storage, ventilation, fuel cells, future perspectives on electricity network and demand side management.

In the following possible and foreseen future developments are described for individual technologies. Please note, that the list is not necessarily exhaustive, and the primary intention is to describe technologies most relevant to the Annex 75 work. Further, please note that references are listed after each subsection throughout the chapter.

### 6.1. Windows

Reducing the heat loss further for windows is difficult (given the state-of-the-art: 4 pane windows with optimized composite framing materials and thermal break seals) and therefore future focus for windows will be on e.g. increasing the control of solar gains so that the energy balance for the window is optimized, or combining windows with other technologies.

#### 6.1.1. *Smart-windows*

New, so-called smart-windows are emerging, i.e. windows where nanocrystals are used to tune different parts of the solar spectrum. A nanocrystalline film is applied to the glass and by controlling the voltage to the film, it is possible to control the amount of infrared light and visible light that passes through the window. Hereby, it is possible to allow infrared light to pass through the window during winter for passive heating of the building and blocking it out during summer to avoid overheating. The possibility of this dynamic controlling makes it possible to optimize the windows energy balance and tailor its performance to the specific building, orientation and changing weather conditions.

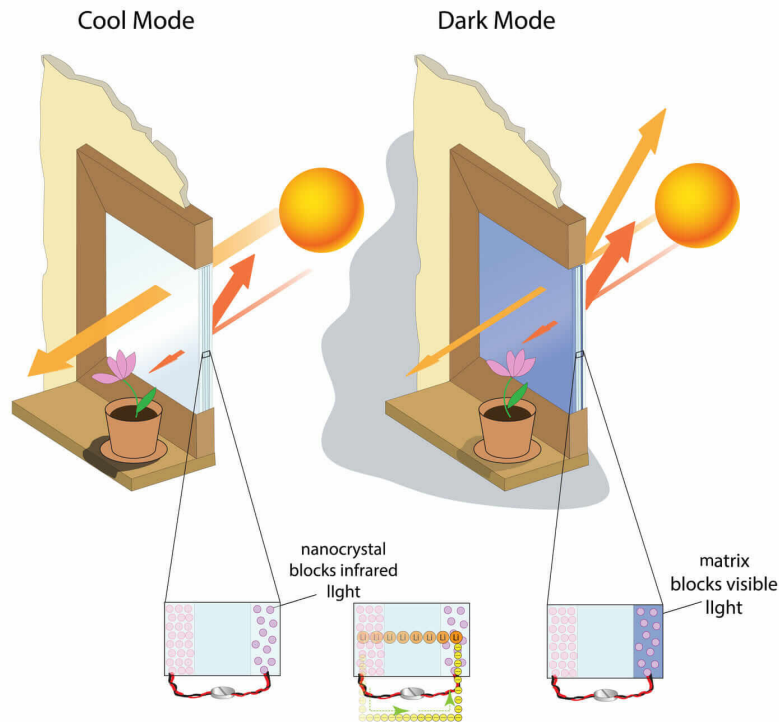

Figure 51. Principle of the system [1].

The automatic control of the glasses is also monitoring the glasses and their performance. Therefore, a message will be given if there is a failure on one of the glasses and the computer will also register any breaking of the glasses by e.g. vandalism or burglary.

Table 17 shows examples of light transmittance, g- and U-values.

Table 17. The relationship between light transmittance, g- and U-values for the windows in “light” and “dark” mode. [2]

	Light transmittance		g-value		U-value (W/m <sup>2</sup> K)
	Light	Dark	Light	Dark	
<b>ConverLight®65</b>					
1 layer glass (44.3)	66%	17%	0.60	0.31	5.29
2 layers glass (44.3-16-6)	61%	15%	0.42	0.13	1.12
3 layers glass (44.3-16-4-16-6)	56%	14%	0.36	0.10	0.58
<b>ConverLight®75</b>					
1 layer glass (44.3)	73%	39%	0.64	0.43	5.29
2 layers glass (44.3-16-6)	67%	36%	0.46	0.25	1.12
3 layers glass (44.3-16-4-16-6)	61%	33%	0.40	0.21	0.58



Figure 52. Left: When there is no need for solar shading the glasses are light and transparent like ordinary windows. Right: When there is a need for solar shading, electricity is applied to the nanocrystalline film and the glass turns darker [2].

Smart-windows were developed at the University of Uppsala. The glasses are covered in tungsten oxide and zinc oxide in Germany and the glasses are autoclaved in either Sweden or Finland. Thermochromic Dynamic Glass [3] works in a similar fashion but is automatically controlled by the heat from the sun, i.e. the warmer the glass gets the darker it turns.

Different films that allow transmission of visible radiation wavelengths, while blocking infrared also exist, but they are not covered here.

### **6.1.2. Window spacer-integrated PV**

Another recent technology development related to windows is the addition of PV solar cells to the spacer of the glass combined with the utilization of a luminescent coating on the glass that leads the sunlight to the edges of the glass in a similar way as an optic fibre [4].

The so-called PowerWindow has a range of advantages:

1. the window maintains its functionality and the aesthetics of the building is not affected,

2. less solar cells per surface area is needed, since only strips on the edges of the window are required (instead of the entire surface area), and
3. roof surface area is not a restriction to produce electricity.



Figure 53. PowerWindow by Physee. Note the tilted PV at the spacer (photo: Jasper Juinen)

#### REFERENCES:

- [1] Future Building Materials: Aerogels, Nanocrystals, and Smart Windows. Micallef, K.  
<https://www.autodesk.com/redshift/future-building-materials/>
- [2] Intelligent solafskærmende glas, Thomsen, M. Glas 1, 2019 (GLAS – Glasteknisk forening).
- [3] Thermochromic Dynamic Glass works BETTER, Suntuitive,  
<https://suntuitiveglass.com/thermochromic-dynamic-glass/>
- [4] SMARTSKIN, <https://www.physee.eu/>

## 6.2. Prefabricated facades

Façades insulation in general, is a continuously growing field for innovation. Future foreseen developments include production innovation, as well as developments on new solutions and materials to be used in the insulation of new-built façades and building renovation. In the development of new materials and systems for prefabricated façades, there is an increasing trend demonstrating an underlying concern regarding the use of low environmental impact materials which at the same time can guarantee a high energy performance of the system, resulting in the

introduction of bio composites materials (such as rice husk, wood fibres and textile waste fibres) and nanotechnology.

In terms of materials, between some of the solutions indicated as research possibilities to become a viable high performance thermal building insulation materials, are vacuum insulation materials, gas insulation materials, Nano insulation materials and dynamic insulation materials. While vacuum and gas insulation materials differ in the filling of the core structure of the material, in gas insulation materials different gases can be used, such as argon, krypton or xenon, with an overall thermal conductivity of less than 4 mW/(m°C) [1]. Nano Insulation materials on the other hand are basically homogenous with a small Nano pore structure (see Figure 54), and a dynamical insulation relies on the ability to control the thermal conductivity of the material within a determined range by, for example, changing the content or the concentration of a gas filling material.

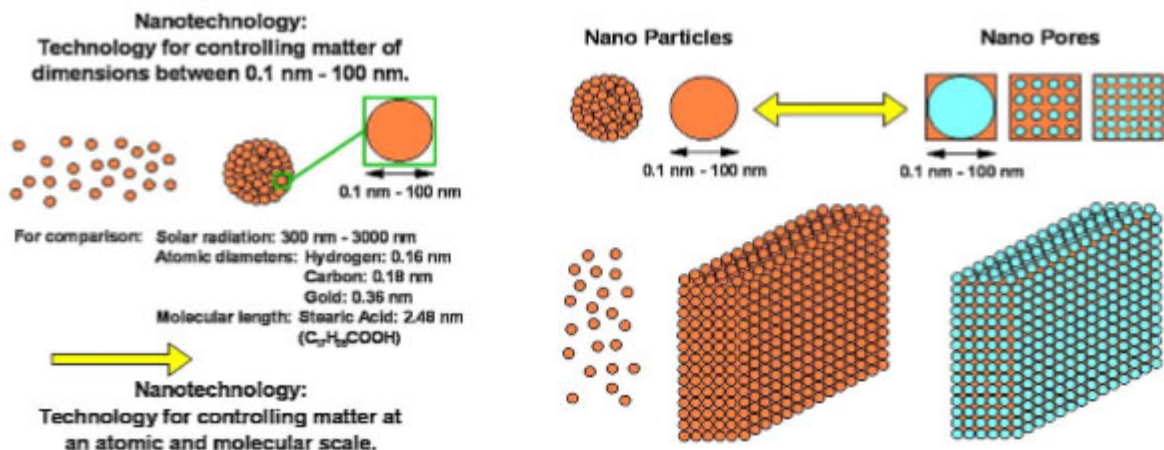

Figure 54. Application of nanotechnology to thermal insulation materials (Source: [1])

External thermal insulation composite system (ETICS) systems are an increasingly popular solution to promote façade insulation, in particular concerning building renovation. Innovation regarding mechanization and prefabrication is expected in the development potential for ETICS systems. Mechanization would allow for faster implementation, savings in product leftovers and less labour. The prefabrication can be incorporated in any part of the ETICS system, with insulating panels and reinforcement prepared in factory with holes for anchors, as an example. In addition to the significant development potential in terms of improvement of the system itself (namely in terms of effectively dealing with material heterogeneities within the system), there is also potential in the use of other thermal insulation materials. A current trend in research has been identified regarding the need for studying well-known insulation materials in the context of ETICS systems, as well as emerging high-performance insulation materials such as Phenolic Foam, Polyurethane Foam and Aerogel Mats [2].

The use of modular systems opens up space for innovative business models, such as one-stop-shops for energy renovation of buildings, which aims to facilitate an integrated response to the process of intervening a building in order to improve its energy performance. There are also

evidences that there will be an increase in the use of innovative technologies such as robotics, 3D-scans, which can bring significant advantages to this type of technology [3].

Another promising future development concerning insulation relates with the use of transparent insulation (TI) materials and systems that can provide thermal insulation and at the same time allow for transmission of solar energy. Although initially related with windows, these kind of systems have been moved to wider solar façades context development, due to the use and testing of new gas filling and materials. Figure 55 makes an overview of the structures and materials used in transparent insulation.

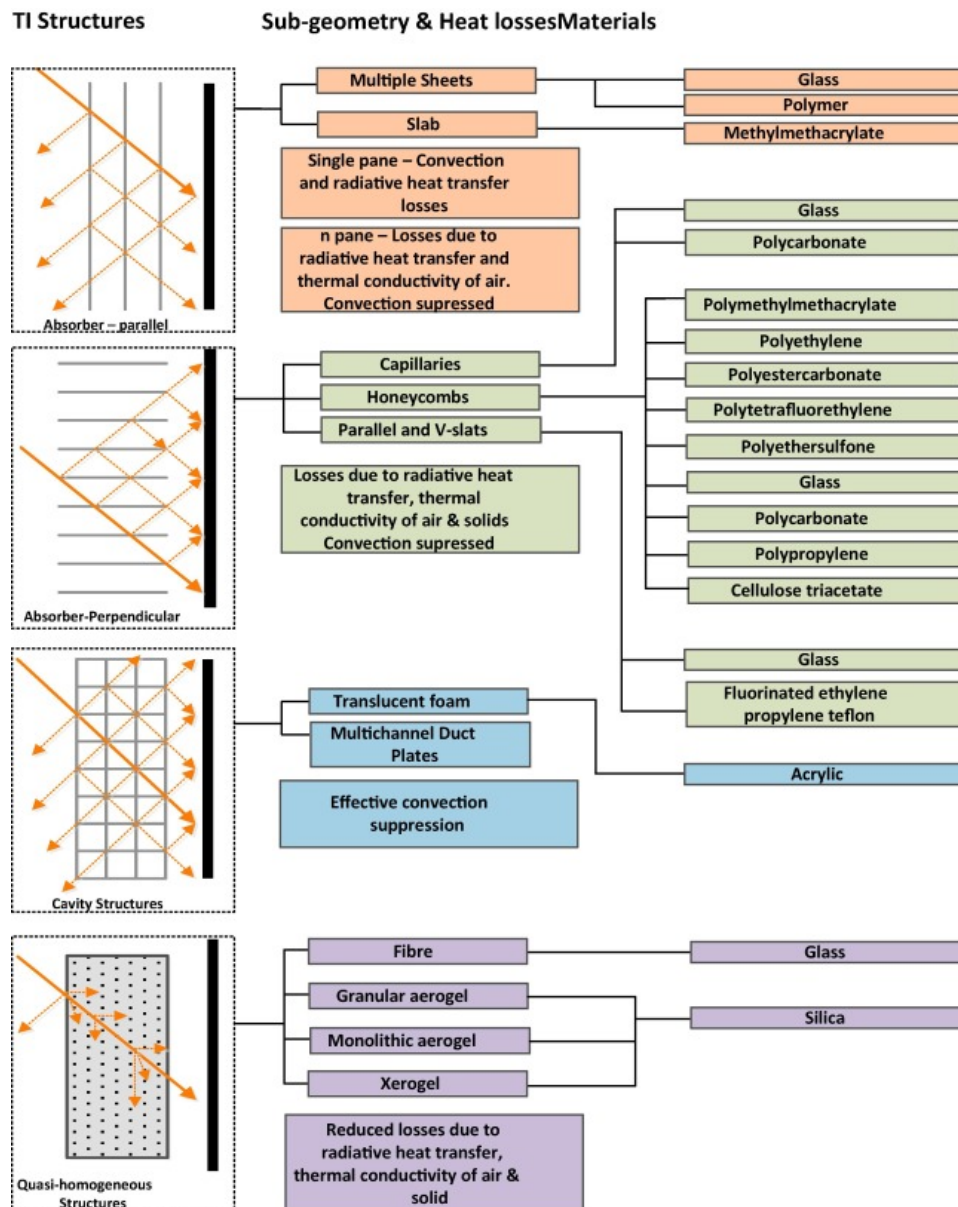

Figure 55. Thermal insulation types and materials [4].

## REFERENCES:

- [1] B. P. Jelle, "Traditional, state-of-the-art and future thermal building insulation materials and solutions – Properties, requirements and possibilities," *Energy Build.*, vol. 43, no. 10, pp. 2549–2563, Oct. 2011.
- [2] Foambuild, "Functional Adaptive Nano-Materials and Technologies for Energy Efficient Buildings." [Online]. Available: <http://www.foambuild.eu/>. [Accessed: 19-Mar-2019].
- [3] BPIE, "Driving transformational change in the construction value chain," 2016.
- [4] A. Paneri, I. L. Wong, and S. Burek, "Transparent insulation materials: An overview on past, present and future developments," *Sol. Energy*, vol. 184, pp. 59–83, May 2019.

## 6.3. Photovoltaics (PV)

### *Efficiency and cost*

Photovoltaic solar cells produce electricity from sunlight, and come in many shapes or forms. The most common technologies are crystalline structures and thin-film. The most efficient PV-panels today have a test efficiency of 24%, but efficiencies up to 46% for single cells have been observed in laboratory testing. It is expected that the efficiency of solar cells and solar cell products will increase in the following years. The increased efficiency will make solar panel technologies more profitable. Combined with the reduction of raw material usage and overall costs in the production, this is expected to be a driver for increased profitability for PV-panels, which will boost the introduction of more PV panels worldwide.



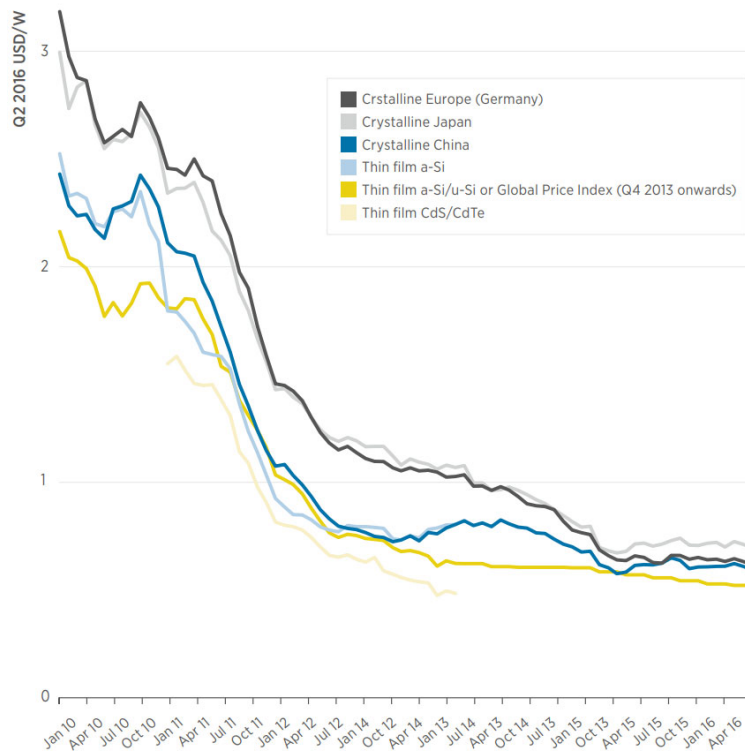
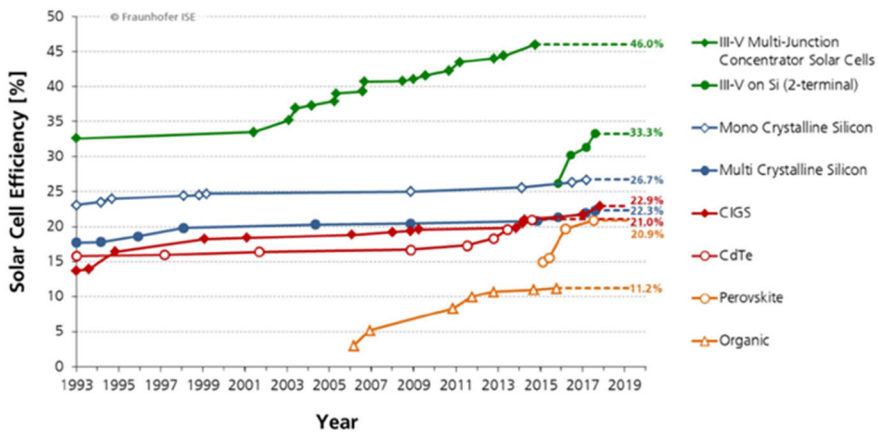

Figure 56. PV module price trends [1]



Data: Solar Cell Efficiency Tables (Versions 1 to 53), Progress in Photovoltaics: Research and Applications, 1993-2018. Graph: Fraunhofer ISE 2019

Figure 57. Laboratory solar cell efficiency development [2]

### Aesthetics

Building integrated photovoltaics are used to replace conventional building parts such as roofs and facades. The focus in the market development seen today is on installation, performance, aesthetic integration and maintenance challenges.

“Photovoltaics only has a future, if it can be integrated harmoniously into architecture.”  
Charles Fritts, inventor of the first solar cell in 1880.

The aesthetics of buildings and technical installations in buildings will continue to be a matter of both concerns and possibilities in the future as well as in the past. The market for solutions that integrate photovoltaics seamlessly into the building roof and facades is expanding, and it is now possible to create coloured solar panels in all shapes and colours, even white or transparent. Coloured solar panels have lower efficiencies than black and blue solar panels, but can make solar panels attractive for many building projects where PV-solutions otherwise would have been dismissed due to aesthetic reasons. So far, the efficiency of lightest coloured solar cells is only about 10%, but dark green, red and brown solar panels can reach efficiencies above 16%.

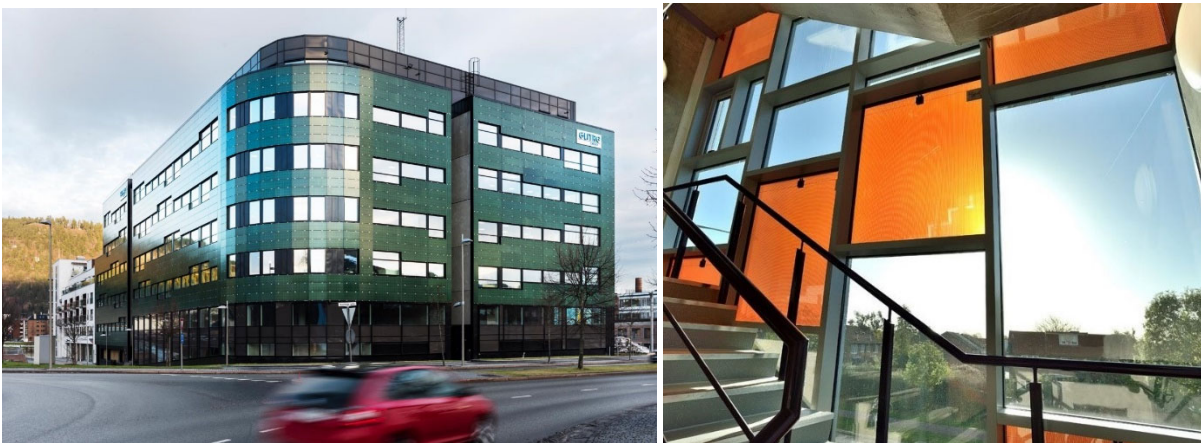

Figure 58. Building integrated solar panels. The Solar Emerald in Norway to the right (Enova) and transparent solar panels to the left (BIPV-Norge).

### *Prefabricated elements*

Using prefabricated building elements with technical solutions is another trend that is likely to reduce construction time and cut installation cost of building façades with solar panels in the future. A prefabricated building is constructed using factory made building elements that are transported to the construction lot. Using prefabricated building elements (prefab) is often a cheaper and faster solution than on-site construction of buildings, and prefab elements are often more dimensionally stable than on-site constructions. Prefabricated building elements with technical installations such as building integrated solar panels have been demonstrated in different demonstration projects. Solar panel installations in prefab facades can either be mounted on the facade element in the factory, or it is possible to install mounting solutions on the prefab elements in the factory and later installing the solar panels on-site (in order to reduce risk of damage of the solar panels during transportation).



Figure 59. Prefabricated facade elements with PV panels being installed during a deep retrofit.

### *Maintenance*

In colder regions, snow and ice influence the solar energy production and can influence the durability of the solar panels. Advanced material surface development can reduce the snow and ice formation on roof top solar panels and increase the solar energy yields in solar panels installed in colder regions.



Figure 60. Snow being removed from solar panels mounted on a roof top in Norway.

### *Hetero-junction (Alpha panels)*

Another new (October 2019) technology development is the so-called hetero-junction technology (HJT), which will come into commercial production very soon. The new technology will increase power output from the standard  $290 W_p$  to  $380 W_p$ , while the efficiency is around 21.7%. HJT technology combines the advantages of crystalline silicon cells with the advantages of so-called thin-film cells. The panels can be produced at lower temperatures than normal, reducing energy demand and thus production costs while minimizing degradation of the materials in the cells during production. The latter makes the use of even thinner wafers in the cells most favourable.

## REFERENCES:

- [1] IRENA (2017), IRENA Cost and Competitiveness Indicators: Rooftop Solar PV, International Renewable Energy Agency, Abu Dhabi.
- [2] Philipps S, Warmuth W. 2018 Fraunhofer ISE photovoltaics report. Available at <https://www.ise.fraunhofer.de/content/dam/ise/de/documents/publications/studies/Photovoltaics-Report.pdf>

## 6.4. Building automation systems/energy management systems

The growing popularity of time of use tariffs and smart, Internet of Things (IoT) connected devices offer opportunities for Energy Service Companies to provide energy management and cost savings for adaptable users, while meeting energy and CO<sub>2</sub> reduction targets [1].

The adoption of HEMS (Home Energy Management Systems) can coincide with the rollout of smart meters and energy bookkeeping systems as a precondition to give energy users feedback about actual energy consumption and to encourage users to lower their consumption [2].

## REFERENCES:

- [1] Reynolds, J., Rezgui, Y., Hippolyte, J.L., 2017, Upscaling energy control from building to districts: Current limitations and future perspectives, Sustainable Cities and Society 35, 816-829, <https://doi.org/10.1016/j.scs.2017.05.012>.
- [2] Meijer, F., Straub, A., Mlecnik, E., 2018, Impact of Home Energy Monitoring and Management Systems (HEMS), Triple-A: Stimulating the Adoption of low-carbon technologies by homeowners through increased Awareness and easy Access, D2.1.1. Report on impact of HEMS, <http://www.triple-a-interreg.eu/project-reports>

## 6.5. Low temperature thermal grid (LTTG)

3rd generation heating networks (conventional district heating <100°C supply temperature) are the current state of the art. Low temperature (LT) 4th generation heating networks (with supply 35-65°C) are increasingly establishing themselves on the market, being planned and implemented. Local low-temperature thermal grids (LTTG+) or 5th gen DH represents a complete innovation in district heating and cooling and goes far beyond previous approaches. In this type of system, significantly lower system temperatures are available and efficient heat pumps are used to raise system temperatures to those specifically required (avoidance of exergy losses) and innovative network topologies and operating modes (e.g. non-directional systems without central network pumps) are used in combination with seasonal storage systems. The innovative elements of LTTG+ to be further developed are in detail:

- Virtually no heat losses: At average ground temperatures of 8-10°C (the usual basis for calculating network losses) and system temperatures in the range of 4-25°C, hardly any relevant heat network losses occur and, in certain operating conditions, even an energy input can theoretically be generated. This makes it possible to use cost-effective non-insulated plastic pipes instead of insulated steel district heating pipes.
- Efficient development of low-exergy heat sources that have not been used for district heating/cooling so far
  - large potential of low-temperature / low-exergy energy sources
    - waste heat energy from different processes
    - solar thermal, PVT, geothermal
    - waste heat from data-centres
  - Decarbonisation of the heat and cold supply
  - Conservation of resources and reduction of energy imports
  - Integration of prosumers
- Provision of a sustainable cooling with the same technical and organisational infrastructure
  - Free-Cooling possible
  - Cold supply is at the same time an energy source for heat supply (regeneration of seasonal storage tanks and system temperatures)
- Significant reduction in primary energy consumption possible with suitable system solutions
  - Additional potential through integration of renewable power sources (PV/PVT)
- Intelligent coupling of heat and cooling supply with other networks and infrastructure
  - Power2Heat option via heat pumps, storage tank and corresponding system control
  - Decentralised waste water heat recovery from the waste water network
  - Peak load coverage from conventional or LT heat networks or injection of surpluses from the LTTG+, possibly used as a storage facility
- High flexibility with regard to expandability (technical resilience through infrastructure that grows and changes with the network) with ring or mesh net topology, undirected flow and flexible temperature levels
  - Integration of new heat and cold sources or sinks
  - Any positioning of decentralised storage (seasonal storage, heat/cold storage on the consumer side)
  - Provision of various "products" (heating and cooling at customer-specific temperature levels)
- Flexibility regarding organizational structure, stakeholder participation, prosumer solutions and business and participation models (organizational resilience).

## 6.6. Ground Source Heat pumps

The market for small ground-source heat pumps (GSHP) has stabilised during the last years, but there is a steady market growth for larger systems for residential buildings as well as in the commercial and institutional sector [1]. Systems with increasing size, deeper boreholes and higher

capabilities are investigated. The distribution and technology development of the GSHP are therefore progressing actively. Research related to heat pumps and geothermal energy is carried out to include energy storage.

Areas of interest concerning the district heating network includes large cavern thermal energy systems for high-temperature storage and cold networks with distributed heat pumps.

Another application of ground-source heat pumps is ectogrid™ [2], a system, which will circulate, reuse and share the energy within a district. This will dramatically decrease the need for supplied energy and save costs. The innovation is not in the components of the system but in the new and novel way they are put together. The heat pumps and the cooling machines can operate against more favourable temperature ranges and the thermal energy distribution becomes more efficient and removes energy losses as well as all traditional large-scale production units. Only one thermal grid is needed, but it serves several purposes – thermal distribution for both heating and cooling as well as storage and flexibility. A basic principle is that one should harvest all thermal energy flows (heating and cooling) and balance them against each other.

This flexible grid connects the city that distributes thermal energy flows between neighbours. Each building connected to the system uses heat pumps and cooling machines. The buildings make energy “deposits or withdrawals” from the grid, which means that the energy demands from all the buildings are balanced against each other.

Energy is only added to the system when needed. If there is a surplus of energy, or if other energy demands need to be prioritized, the system’s temperature can be raised or lowered. Depending on the demand for heating and cooling, it can also change temperature. It works like a giant thermal battery – making more room for intermittent renewable energy, as Figure 61 shows. The system does not have any distribution losses, as it operates with the same low temperature as the surrounding earth. It can be applied in district, neighbourhood or city level and lean on district heating grid.

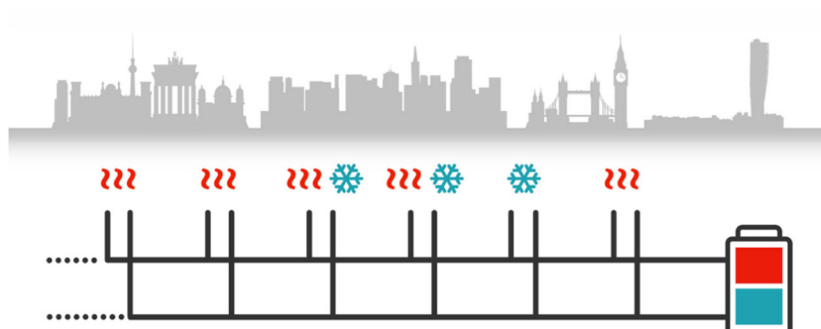

Figure 61. Ectogrid™ works like a giant thermal battery and has no distribution losses as it operates with the same low temperature as the surrounding earth [2].

The world's first ectogrid™ is available at Medicon Village in Lund, Sweden, a life science park, as shown in Figure 62. Effective use of the surplus energy that arises in Medicon Village operations drastically reduces the entire area's energy needs. Construction started in autumn 2017, the physical installation of the grid started in the summer of 2018 and by 2020, all buildings are expected to be connected to the system and reach the full capacity [3, 4].

The temperature in the uninsulated grid can vary freely between 5°C and 40°C depending on the demands of heating and cooling and the temperature of the surrounding earth. As the system operates at such low temperatures, it can make use of all thermal waste energy available in buildings and in a city. A software then uses the real-time data to steer and optimize the energy flow and storage.



Figure 62. An illustration of the ectogrid™ at Medicon Village [2].

As discussed above, heat pumps recovering heat from local cooling devices and places that produce heat, like data centres, to district systems is under current development.

#### REFERENCES:

- [1] Gehlin S, Andersson O. Geothermal Energy Use, Country Update for Sweden. European Geothermal Congress Strasbourg, 2016.
- [2] About - E.ON ectogrid. [ectogrid.com/about/](http://ectogrid.com/about/). Published 2019.
- [3] ectogrid™ | Energirevolutionen är här - E.ON. Eon.se. [www.eon.se/om-e-on/innovation/ectogrid.html](http://www.eon.se/om-e-on/innovation/ectogrid.html). Published 2019.
- [4] Jensen T. Game changing technology connects Medicon Village buildings. [Mediconvillage.se](http://Mediconvillage.se). [www.mediconvillage.se/sv/game-changing-technology-connects-medicon-village-buildings](http://www.mediconvillage.se/sv/game-changing-technology-connects-medicon-village-buildings). Published 2018.

## 6.7. Solar thermal

There is evidences suggesting that, in terms of market development, solar installation supporting district heating systems, as well as heating and cooling applications in commercial and industrial settings have gained interest and scale in recent years [1]. Even though it is quite developed in some parts of Europe, there are research indicating that the cost of a large scale district solar heating system can be significantly reduced in relation to individual systems and that for that reason is being considered as a future development in coming years, in particular in conjunction with seasonal storage [2].

This trend should be also placed in context with the continuous development of solar technologies. For example, polymeric collectors are a different approach with significant weight and cost reduction. In addition, recycled polymeric materials can be used. Another significant advance is the introduction of different filling gases in solar collectors. Experiments considering gases such as Xenon and Argon suggest that flat plate collectors can obtain higher thermal performance with a thinner collector design and reduced weight [3].

In terms of technology, there are indications that some novel concepts can improve substantially solar thermal cooling systems, both for adsorption chillers and for absorption chiller, using system optimization for an improved balance between solar thermal energy input and cooling output. In the past, this technology was considered to be expensive, however there some prospects regarding cost reduction that can help further developments in the future [4], which can be significant for wider implementation in e.g. Southern Europe. Figure 63 gives an overview of solar thermal cooling technology.

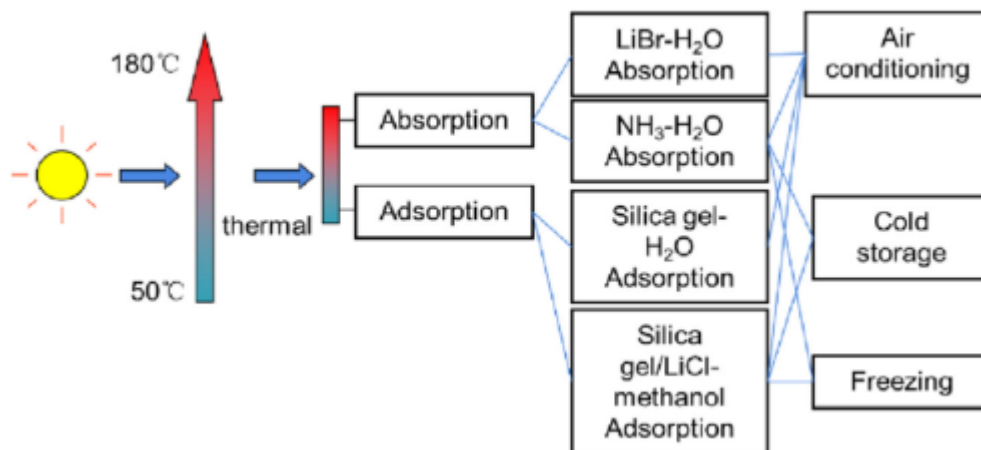

Figure 63. Solar Thermal Cooling Technology (Source:[2])

Some studies argue that the main research and development direction is how to integrate solar collecting systems in buildings. In that regard, solar façades have been gaining traction in both research and product development. According to some research, building-integrated solar thermal (BIST) collectors can be 40% more efficient in comparison to building-attached collectors installed



after the initial construction or retrofitting [5]. One clear example is the development of the Solar Thermal Venetian Blind (SBTV) (Figure 64).

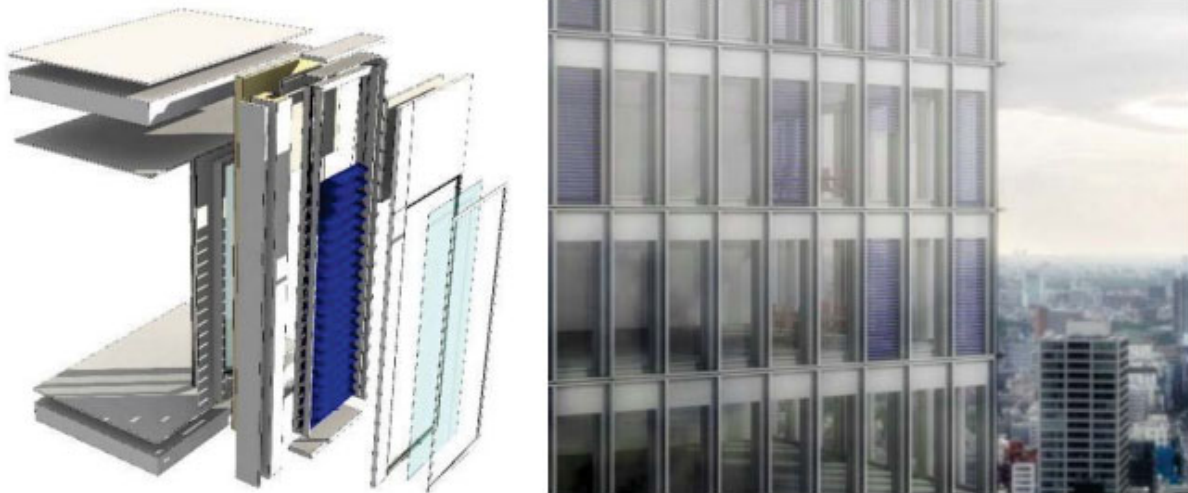

Figure 64. Buildup and possible integration of the Solar Thermal Venetian Blind (Source: [5])

The SBTV functions by incorporating heat pipes into each slate of the blind. The slate acts as an absorber for solar radiation and the heat is transferred to a main tube, much like a conventional vacuum tube collector panel. Various operation strategies can be used, ranging from maximizing the indoor lighting to taking full advantage of heating provided by solar radiation.

Another potential development in terms of building integration is demonstrated by the TABsolar product (Figure 65). The TABsolar [5] uses ultra-high performance concrete and integrate fluid channels in that material. In that way, it can be used as a solar thermal façade collector or a thermo-active building system for heating and cooling inside the building.



Figure 65. TABsolar panels (Source: [5])

#### REFERENCES:

- [1] W. Weiss and M. Spörk-Dür, "Solar Heat Worldwide Detailed Market Figures 2016 2018 EDIT I O N Global Market Development and Trends in 2017," 2018.
- [2] T. S. Ge et al., "Solar heating and cooling: Present and future development," *Renew. Energy*, vol. 126, pp. 1126–1140, Oct. 2018.
- [3] P. A. Kulkarni, S. P. Sabnis, and R. Sarangi, "Recent investigations in solar flat plate collectors," in *2015 International Conference on Technologies for Sustainable Development (ICTSD)*, 2015, pp. 1–6.
- [4] R. M. Lazzarin and M. Noro, "Past, present, future of solar cooling: Technical and economical considerations," *Sol. Energy*, vol. 172, pp. 2–13, Sep. 2018.
- [5] P.-R. Denz et al., "Solar thermal facade systems – an interdisciplinary approach," in *CONFERENCE ON ADVANCED BUILDING SKINS 2018*, 2018.

## 6.8. Thermal storage

Thermal storage can be split into two main categories; short term thermal storage (day-to-day or hour-to-hour) or long-term thermal storage (seasonal). Short-term thermal storage will usually utilise the latent heat capacity of phase change materials or the heat storage capabilities of thermochemical materials. Long-term thermal storage typically utilises water or soil as a storage medium, e.g. in pit thermal storage, borehole thermal storage, aquifer thermal storage or tank thermal storage.

### 6.8.1. Phase change materials [PCM]

Many studies confirm that thermal mass is effective in improving building's interior comfort, in places with high diurnal temperature variation. Thermal mass, combined with other passive strategies, can play an important role in the buildings energy efficiency, minimizing the necessity of the traditional conditioning systems. The most traditional thermal energy storage (TES) application in building is the thermal mass, but in the contemporary construction the use of lightweight materials and components with low thermal storage capacity, is becoming more common. Phase Change Materials (PCM) add the thermal mass benefits to the lightweight constructions [1].

Phase Change Materials (PCM) has large energy heat storage capacity, with an isothermal behaviour during the charging and discharging process [2]. This means that PCM performs similar to the traditional thermal mass materials with the followings advantages: they are lighter, more flexible and compact, they have higher heat storage density, and they store and release the thermal energy at nearly constant temperature. There are PCM for almost any melting/solidification temperatures, researchers have identified a large number of substances with a high latent heat of fusion in any required temperature range [3].

The latent heat thermal storage is an efficient way to match availability and demand of thermal energy, with respect to time and power. The PCM applications contribute to increase both, the buildings energy efficiency and the use of renewable energy. The PCM applications have been used for both heating and cooling, although new PCM for cooling products have appeared in recent years. The wide possibilities of PCM microencapsulation and composite materials have facilitated the integration of latent thermal storage in buildings.

All kind of Passive and active systems have been presented in all editions of Solar Decathlon Europe Competitions [4] [5], and constitute a very good sample of its better applications. Some of them are:

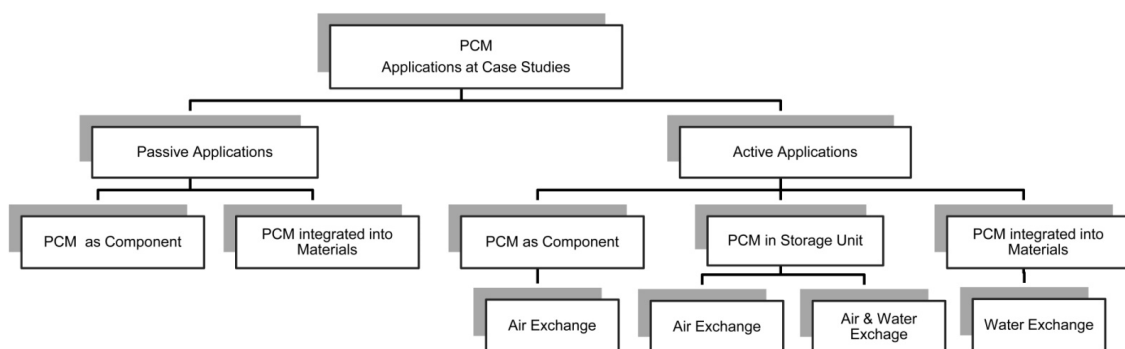

Figure 66. Main PCM Applications classification diagram [1].

Support strategies with low consumption devices as summer force air night ventilation or the use of night radiation to cool the water, have been used to improve the PCM performance, taking advantage of the environment conditions.

Undoubtedly, the use of this type of materials in buildings has a suggestive potential that is being explored and developed by many research teams around the world, e.g. being the prototypes that participate in Solar Decathlon competitions, a perfect sample of innovative applications of PCM combined with other passive and active strategies and technologies.

### 6.8.2. Seasonal thermal storage

The following description is a merging/rewrite of the descriptions given in the Danish Energy Agencies technology catalogue [6].

Seasonal heat storage (for district heating purposes) is normally based on water as storage medium, but other storage mediums can be used as well. Seasonal heat storages are generally defined as storages with a storage cycle longer than one week up to one year.

There are four main categories for long-term (seasonal) heat storage for district heating systems:

- PTES, pit thermal energy storage (focal technology in the chapter)
- BTES, borehole thermal energy storage, ground storage with closed loops
- ATES, aquifer thermal energy storage, ground storage with open loops
- TTES, tank thermal energy storage

For PTES and TTES, treated water (district heating water) is the storage medium in order to avoid corrosion. For ATES and BTES, the surrounding soil or aquifer is the storage medium. Figure 67 shows the principles of the four seasonal thermal storage concepts.

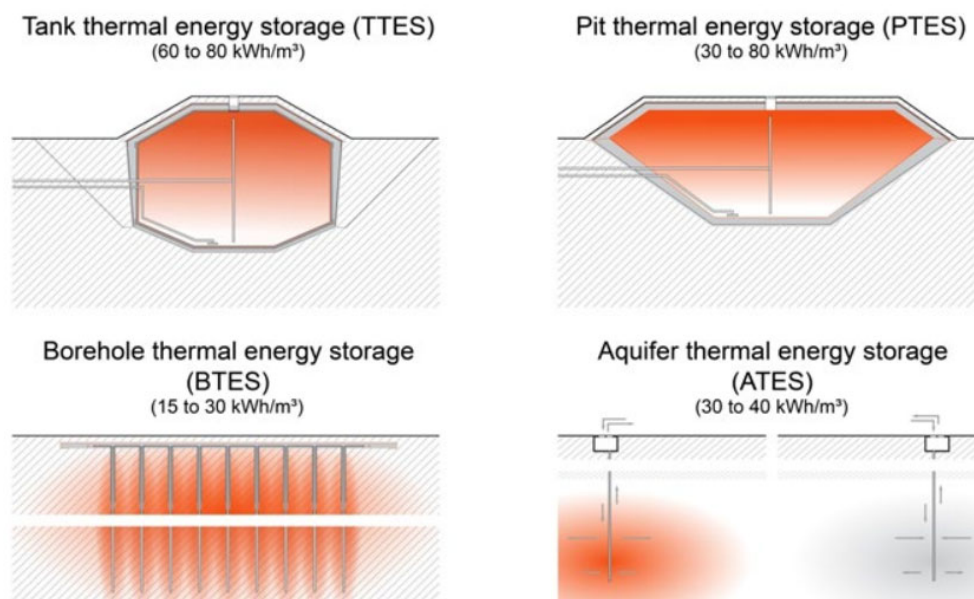

Figure 67. Seasonal thermal energy storage – concepts. Specific storage capacity given at typical operation temperatures of the given storage concepts [7].

Table 18. Advantages and disadvantages for thermal storage types.

<b>Advantages</b>		
<b>PTES</b>	<b>BTES</b>	<b>ATES</b>
<ul style="list-style-type: none"> <li>• High storage capacity possible</li> <li>• Quick charging and discharging with high capacity</li> <li>• High specific heat capacity</li> <li>• Cheap storage medium with good heat transfer characteristics</li> <li>• Enables stratification</li> </ul>	<ul style="list-style-type: none"> <li>• Requiring relatively small area of land</li> <li>• Very limited visual impact</li> <li>• Expandable</li> <li>• Limited risk of leakages (possible to close one loop)</li> <li>• Closed system</li> <li>• Long lifetime</li> </ul>	<ul style="list-style-type: none"> <li>• Low investment costs</li> <li>• Low operation costs</li> <li>• Small physical footprint</li> <li>• Scalable, easy to expand</li> <li>• Low temperature storage (flexible application)</li> <li>• High storage capacity in each borehole-pair (1.2-1.4 GWh at 10 °C temp. difference and 2000 hours)</li> </ul>
<b>Disadvantages</b>		
<b>PTES</b>	<b>BTES</b>	<b>ATES</b>
<ul style="list-style-type: none"> <li>• Requiring a relatively large area of land</li> <li>• Risk of difficult establishment (excavation) due to climatic conditions (rainfall)</li> <li>• Availability of site can be crucial for feasibility</li> <li>• Vulnerable liner and insulation materials, resulting in a risk of leakages, if not treated properly</li> </ul>	<ul style="list-style-type: none"> <li>• Unknown sub-surface conditions (risk of higher investment costs)</li> <li>• Risk of heat loss due to ground water flow</li> <li>• Buffer tank required</li> <li>• Application of heat pump required</li> <li>• Slow charging and discharging</li> </ul>	<ul style="list-style-type: none"> <li>• Risk of thermal short circuit of ground water</li> <li>• Several parameters influence the feasibility</li> <li>• Low storage temperatures (20°C)</li> <li>• Open system (direct use of ground water in aquifer)</li> </ul>

Environmental risks may include: For PTES and BTES, there is the general risk of leakage of treated water, and if not planned properly PTES can have a substantial visual impact on the surrounding landscape. Especially for ATES and BTES, there is a risk of heating of ground water surrounding the storage. Heating the aquifers to more than the legal 20°C (average temperature) may result in bacterial growth.

A general research and development objective is the improvement of modelling of seasonal heat storages in order to improve the planning security in investment decisions [8]. The main research topics are listed for each technology below.

For PTES in particular, developing liner materials that are resistant to high temperatures and moisture-resistant insulation materials over long periods are key focus areas. For BTES the

expectation is that future developments will make BTES competitive with PTES, due to a longer lifetime. For ATES high temperature storage requires more research in order to ensure reliable operation (low temperature storage in ATES is more mature, and is feasible and already proven in stable operation) and finally, development of a replicable screening program for suitable sites for ATES is needed (e.g. methods to easily identify relevant aquifers, including information regarding e.g. flow).

#### REFERENCES:

- [1] E. Rodríguez-Ubiñas\*, L. Ruíz-Valero, S. Vega Sánchez & F.J. Neila González Applications of Phase Change Material in high energy efficient houses. *Energy and Buildings* 50 (2012) 49–62
- [2] Mehling H, Cabeza L. Heat and cool storage with PCM: An up to date introduction in to basics and applications. Springer –Verlag Berling Heidelberg, 2008
- [3] Sharma A, Tyagi V, Chen CR, Buddhi, D. Review on thermal energy storage with phase change materials and applications. *Renewable and Sustainable Energy Reviews* 13 (2009) 318–345
- [4] S.Vega et al. “SOLAR DECATHLON EUROPE 2010, Towards Energy Efficient Buildings”. FGUPM, ISBN 978-84-15302-02-5, Madrid 2011
- [5] S.Vega et al. “SOLAR DECATHLON EUROPE 2012, Improving Energy Efficient Buildings”. FGUPM, ISBN 978-84-695-8845-1, Madrid 2013
- [6] Technology data for energy storage – Technology descriptions and projections for long-term energy system planning, Danish Energy Agency (2018) (updated January 2020).
- [7] Sørensen, P. A. & Schmidt, T. (2018). Design and Construction of Large Scale Heat storages for District Heating in Denmark. 14th International Conference on Energy Storage, 25-28 April 2018, Adana, Turkey.
- [8] PlanEnergi (Danish company; [www.planenergi.dk](http://www.planenergi.dk)), which has been involved in several pit heat storages in Denmark and internationally.

## 6.9. Electrical storage

As the market for electrical energy storage is expected to grow exponentially over the coming years there is a great push for further developments towards increased cost efficiency of both battery types – Solid State Batteries (SSB) and Flow Batteries (FB).

SSB (Solid State Battery): Continued innovation has created new technologies like electrochemical capacitors that can be charged and discharged simultaneously and instantly, and provide an almost unlimited operational lifespan. Large production facilities has been and is being built and with these follows a large development department that will further boost the technology.

FB (Flow Battery): The increased demand for longer-term electrical storage with almost no losses will result in an accelerated development of these batteries towards an increased price/performance ratio.

### **6.9.1. Lithium-ion batteries (LIB) for grid-scale storage**

The following was taken from the Danish Energy Agencies energy storage technology catalogue [1].

*Within the last decade the commercial interest for electricity storage using LIB systems has increased dramatically. The production volume is still limited and there is a promising potential for cost reductions through upscaling. The technology is stand-alone and requires a minimum of service after the initial installation.*

*Currently a wide range of government and industry-sponsored LIB material, cell, and system level research is taking place. Some of the ongoing material research to further increase the energy density of LIB cells includes high-voltage electrolytes allowing charging voltages of up to 5 volts [2] and silicon nanoparticle based anodes to boost the charge capacity [3]. Several research and development activities focus on improving the cycle lifetime of LMO cells [4–6].*

*Some of the most promising post Li-ion technologies include Lithium Sulphur batteries that use Sulphur as an active material. Sulphur is abundantly available at reasonable price and allows for very high energy densities of up to 400 Wh/kg. Also Lithium air batteries have received considerable attention. Since one of the active materials, oxygen, can be drawn from the ambient air, the lithium-air battery features the highest potential energy and power density of all battery storage systems. Due to the existing challenges with electrode passivation and low tolerance to humidity, large-scale commercialization of the lithium-air battery is not expected within the next years.*

*Several non-lithium-based battery chemistries are being investigated. Aluminium Sulphur batteries may reach up to 1000 Wh/kg with relatively abundant electrode materials, but are still in the very early development phase [7].*

*Besides the materials research, improved cell design, battery management system (BMS), thermal management system (TMS) and energy management system (EMS) technology and operation strategy can improve storage efficiency considerably [8]. Although LIB systems for electricity storage are now commercially available, the R&D is still in its relatively early phase and is expected to contribute to future cost reductions and efficiency improvements.*

### **6.9.2. Vanadium redox flow batteries**

The following was taken from the Danish Energy Agencies energy storage technology catalogue [1].

*Vanadium redox flow batteries or just vanadium redox batteries (VRB) are rechargeable batteries and applicable at both grid and local user level.*

*VRB are under rapid development. There is significant potential for R&D to reduce cost of all battery components [9], [10]. An example is research in use of non-aqueous electrolytes [11]. The minimum cost will, however, likely be limited by the vanadium cost. The vanadium cost is not fixed in the sense that there is a potential for use of lower cost vanadium sources in production than those traditionally used [12].*

*There is a significant potential for cost reduction of flow batteries by using alternative reaction chemistries, i.e., other redox couples than vanadium [10]. Grid scale redox flow batteries could potentially be based on, e.g., zinc-bromide, bromide-polysulphide, iron-chromium, and zinc-chloride [10].*

### **6.9.3. Vehicle-to-grid (V2G)**

Vehicle-to-grid (V2G) is the possibility for utilising the extra capacity of batteries of electric vehicles as storage for the grid. A thorough theoretical study was made in [13] and this analysis shows that even with a modest distribution of electric vehicles (2.5% of all cars in Denmark, corresponding to 55,000 electric vehicles of 2.2 mill.) there are financial benefits for both car owners, wind turbine operators and society.

The analysis concludes that it will not be possible for electric car owners to engage in V2G with the present battery cost. However, this should change by the year 2022 because of falling battery costs and increased energy savings. Furthermore, if V2G will not be able to compensate electric car owners their initial investment, the strategy will not break through and gain distribution.

Another important issue for V2G is that it needs to be available at the early stages when the need for storing wind energy arises. Otherwise, alternative solutions will be utilized and saturate the market, thus making it impossible to penetrate later with V2G.

#### **REFERENCES:**

- [1] Danish Energy Agency (2018). Technology Data – Energy Storage.
- [2] R. Petibon, J. Xia, L. Ma, M.K.G. Bauer, K.J. Nelson, J.R. Dahn. Electrolyte System for High Voltage Li-Ion Cells, J. Electrochem. Soc. 163(2016) A2571–A2578. doi:10.1149/2.0321613jes
- [3] A. Casimir, H. Zhang, O. Ogoke, J.C. Amine, J. Lu, G. Wu. Silicon-based anodes for lithium-ion batteries: Effectiveness of materials synthesis and electrode preparation, Nano Energy. 27 (2016) 359–376. doi:10.1016/j.nanoen.2016.07.023
- [4] M. Saulnier, A. Auclair, G. Liang, S.B. Schougaard. Manganese dissolution in lithium-ion



positive electrode materials, *Solid State Ionics*. 294(2016) 1–5.  
doi:10.1016/j.ssi.2016.06.007

- [5] E.-Y. Kim, B.-R. Lee, G. Yun, E.-S. Oh, H. Lee. Effects of binder content on manganese dissolution and electrochemical performances of spinel lithium manganese oxide cathodes for lithium ion batteries, *Curr. Appl. Phys.* 15(2015) 429–434.  
doi:10.1016/j.cap.2015.01.029
- [6] S. Lee, E.-Y. Kim, H. Lee, E.-S. Oh. Effects of polymeric binders on electrochemical performances of spinel lithium manganese oxide cathodes in lithium ion batteries, *J. Power Sources*. 269 (2014) 418–423. doi:10.1016/j.jpowsour.2014.06.167
- [7] eeNews Power Management. Revolutionary solid state rechargeable aluminium-sulfur battery project starts, (2017). <http://www.eenewspower.com/news/revolutionary-solid-state-rechargeable-aluminium-sulfur-battery-project-starts>
- [8] M. Schimpe, M. Naumann, N. Truong, H.C. Hesse, S. Santhanagopalan, A. Saxon, A. Jossen. Energy efficiency evaluation of a stationary lithium-ion battery container storage system via electro-thermal modeling and detailed component analysis, *Appl. Energy* 210(2018) 211.  
doi:10.1016/j.apenenergy.2017.10.129
- [9] L. Baumann and E. Boggasch, “Experimental assessment of hydrogen systems and vanadium-redox-flow-batteries for increasing the self-consumption of photovoltaic energy in buildings,” *Int. J. Hydrogen Energy*, vol. 41, no. 2, pp. 740–751, 2016.
- [10] O. Teller et al., “Joint EASE/EERA Recommendations for a European Energy Storage Technology Development Roadmap Towards 2030,” 2013.
- [11] M. Guarnieri, P. Mattavelli, G. Petrone, and G. Spagnuolo, “Vanadium Redox Flow Batteries: Potentials and Challenges of an Emerging Storage Technology,” *IEEE Ind. Electron. Mag.*, vol. 10, no. 4, pp. 20–31, 2016.
- [12] M. Manahan, N. Jewell, D. Link, and B. Westlake, “Program on Technology Innovation: Assessment of Flow Battery Technologies for Stationary Applications,” EPRI, 2016.
- [13] Horstmann, J. and Nørgaard, F. “Wind optimized charging V2G”, *Vindenergi Danmark & Danish Energy Agency*, 2015.

## 6.10. Ventilation

Research for more energy efficient HVAC systems is going on which include nano-technological coatings and surface treatments for improved heat transfer; new nano- and micro-materials for improved efficiency of the refrigerants, and improved efficiency and heat transfer capabilities of coolants via new nano-technological additives.

Furthermore, research is going on to integrate heat recovery technology into passive ventilation systems.

Another research topic concentrates on a new residential ventilation system with a balanced, constant air volume system with heat recovery, which enables regulation of the supply air temperature in each individual room in a house. Room level temperature control creates a possibility for a successful operation of the system in terms of providing thermal comfort in each room of a building. The novelty of the new system is based on a component, called a manifold (i.e. a junction box from which a number of smaller ducts branch off), which contains a built-in water heating coil and temperature dampers on each of the outlets. The primary function of the manifold is to distribute the total supply airflow rate into different rooms. The supply air is then delivered to the rooms via a number of separate ducts connected to the manifold. A centralized heating coil is installed in the manifold in order to integrate individual space heating in the ventilation system. Thus, heating of the ventilated zones can be handled solely by the ventilation system. In combined ventilation and heating systems where the supply airflow rate is constant, the control of the heating power delivered via the system is done by regulation of the supply air temperature. The temperature dampers in the manifold ensure that the supply air temperature serving different rooms is adjusted in order to meet the heating demand. The position of each temperature damper is regulated based on the signal from the corresponding room regulator. Thus, the system enables supplying air with various temperatures to different rooms and can cover different heating demands in rooms at the same time. Heating and ventilation system is automatically controlled based on wireless technology. The wireless technology enables flexible location of sensors and actuators and provides easily accessible information about the indoor environment in the building.

Demand controlled ventilation is another kind of ventilation that could be more and more used in the future. Though it has to be mentioned that the use of demand controlled ventilation don't reduce the energy demand in countries, where the requirements have a certain minimum ventilation rate.

Mechanical ventilation is often a requirement in offices and schools, but not in dwellings. Although e.g. in Denmark, it is voluntary to use either natural or mechanical in dwellings, it is often necessary to enforce mechanical ventilation due to the strict energy requirements in the Building Regulation. The trend is that it will be more common to use mechanical ventilation in the future.

More use of air cleaners in schools, commercial buildings and dwellings could also be a future trend. The air cleanser can be used instead of increasing the air volume and is able to reduce the air pollution. Though, not all kind of pollution can be reduced and the air cleaner can even produce some pollution itself.

## **6.11. Fuel cells/hydrogen production**

Fuel cells are electrochemical devices that convert fuel into electricity and heat. Generally, the conversion efficiency from fuel to electricity is high in a fuel cell and the technology is scalable without loss of efficiency. The proton exchange membrane (PEM) fuel cell consists of a cathode and an anode made of graphite and a proton conducting polymer as the electrolyte as shown in Figure 68

[1]. Low temperature PEM fuel cells (LT-PEM) operate at temperatures below 100 °C (typically around 80 °C) since the membrane must be saturated by water.

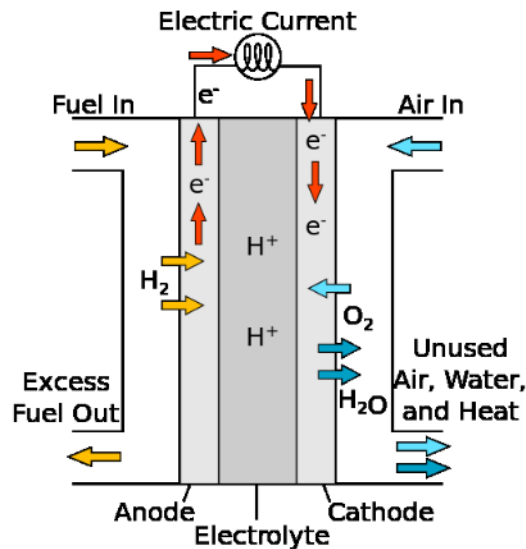

Figure 68. Diagram of a PEM-FC [2].

Today, the larger power and heat generating units (fuel cell combined heat and power – FC-CHP) are typically arranged for integration in conjunction with industrial processes where hydrogen is a waste gas from the industrial processes e.g. production of chloric gas. In many of the early units, only the electricity as output is used. In the future, the hydrogen used for the fuel cell may be produced from electrolysis based on fossil free electricity. Additionally, the potential of the LT-PEM fuel cell for transport purposes and within the realm of microCHP installations has been estimated to be significant [1].

The technology has good part load and transient properties. The regulation of PEM systems can be designed to achieve close to 0% nominal load without significant loss of efficiency. Furthermore, the start-up time of the technology is short and the fuel cells can start and operate at room temperature and has no problems with frequent thermal cycling (start/stop). Response time from cold start during hard frost is very short, i.e. down to a few seconds.



Figure 69. A 50 kW LT-PEMFC CHP hydrogen unit from Dantherm Power.

PEM fuel cells can usually work as both a fuel cell and a water electrolysis cell, i.e. converting hydrogen into electricity and heat in one process and converting water and electricity into hydrogen in the reverse process. This means that the fuel cell can store excess electricity as hydrogen when production from e.g. wind turbines is high and use this hydrogen as fuel when production is low.

Combining PEM-FC with electricity based on renewable energy sources like wind-turbines or photovoltaics means that it is possible to store excess production as hydrogen, which can be used as fuel in the PEM-FC at a time where there is a shortage of electricity production. Stored hydrogen could also be used for transportation purposes in e.g. cars.

The fuel cells produce both electricity and heat and in order to obtain maximum efficiency the heat should be utilized as well, e.g. by heat pumps connected to a district heating system.

The main advantages include:

- The PEM-FC utilizes the scalability of the fuel cell technology to produce electricity locally with efficiencies equal to or higher than for conventional power plants.
- Larger FC-CHP units in the grid can support the grid companies in balancing the grid.
- The grid balancing property of the PEM-FC contributes to reduced additional investments in infrastructure e.g. cables.
- Hydrogen produced from excess electricity based on renewable sources can be stored in hydrogen storages and utilised in the PEM-FC in situations, where wind turbines, solar PV and other renewable technologies are not available.

The main disadvantages include:

- Relatively high production costs today due to expensive materials (platinum).

- The lifetime of the current technology needs to be improved.

The fuel cell technology has shown high electrical efficiency above the efficiencies of competing power generation technologies. However, the fuel cell technology still needs to be matured on issues like lifetime and cost reduction. In Portugal several studies have been done in order to implement the production of Green Hydrogen [3] and [4].

The investment costs are projected to decrease from 1.9 to 1.5 M€/MW by 2020, 0.7 M€/MW in 2030 and 0.6 M€/MW by 2050 according to the projection of the IEA Technology Roadmap - Hydrogen and Fuel Cells, 2015 [5]. Operation and maintenance costs are 95,000 €/MW/year and expected to drop to 65,000, 55,000 and 40,000 by 2020, 2030 and 2050 respectively. The typical generation capacity is expected to increase from around 0.1 MW in 2020 to approximately 2 MW in 2050, while the electrical efficiency is expected to increase to 50%. If these projections are correct, fuel cells are bound to become a key technology in future energy systems.

#### REFERENCES:

- [1] Partnerskabet for brint og brændselsceller, Fuel Cell Technologies, <http://www.brintbranchen.dk/>, visited 18.10.2018.
- [2] Wikipedia, Proton exchange membrane fuel cell, [https://en.wikipedia.org/wiki/Proton\\_exchange\\_membrane\\_fuel\\_cell](https://en.wikipedia.org/wiki/Proton_exchange_membrane_fuel_cell), visited 23.10.2019.
- [3] Partidário, Paulo & Aguiar, Ricardo & Martins, Paulo & Rangel, Carmen & Cabrita, Isabel. (2019)
- [4] The hydrogen roadmap in the Portuguese energy system – Developing the P2G case. International Journal of Hydrogen Energy. 10.1016/j.ijhydene.2019.10.132.
- [5] Technology Roadmap - Hydrogen and Fuel Cells, 2015, International Energy Agency.

## 6.12. Future perspectives on electricity network

In order to improve the efficiency of the power grid, technologies of so-called “smart grids” are being developed. Many challenges arise here:

- Improvement of European and national power grids interconnection, as there is the need to guarantee a production adjusted as closely as possible to the demand, and manage it in an intelligent way, regulating and balancing the grid.
- One of the main technological barriers in this sense is how distributed generation of energy is incorporated into the Grid without significantly unbalancing them and without affecting the continuity and homogeneity of services. Local and district “smart grids” must be developed

in order to control the energy produced in districts and cities according to the concept of distributed generation, which can be much more efficient.

- Buildings themselves, by enabling energy generation (micro-generation) in order to meet, totally or partially, its own energetic demand. Demand management systems and the adjustment of the consumption to the availability (price) of the energy would help regulate and balance the demand. (See 6.13 DEMAND SIDE MANAGEMENT)
- The need to manage energy, from an individual building to the district scale, is another imperative challenge. With the increasing use of information and communication technologies (ICTs), district-scale energy management (EM) is realised by connecting the building demand-side with the district supply-side. However, district-scale EM is a complex, information-driven process [1]. It requires an exchange of information from domains controlled by different stakeholders. Hence, stakeholders' involvement is necessary to facilitate information exchange and promote EM. Furthermore, a massive amount of cross-domain information and data may be generated because of the complexity of EM. A systematic method used to extract and exchange the key information that addresses the stakeholders' performance goals needs to be identified. The Smart Grid, and how to manage the demand from the exchange of key information between the different buildings and the Grid, is another of the relevant challenges under investigation today [2] [3].
- Citizens' behaviour and Facility Managers performance are another of the key challenges. To operate efficient buildings in the best way, Facility Managers need agile tools to provide the most accurate technical decisions according to real existing buildings (Performance BIM), updated information from its environment (weather conditions, district information-Performance GIS, energy uses-SCADAS, utilities information), users' behaviour and necessities (KPIs, sustainable issues etc.), and short term and midterm forecasts (weather forecast, energy production, energy necessities etc.) Existing FM tools as BMS (Building Management Systems), BEMS (Building Energy Management Systems), and CAFM (Computer Aided Facility Management) provide operative decisions support only partially. This is because of a limitation of information flow, short feedback and forecast and missing models necessary for simulation and decision support. Existing IWMS (Integrated Workplace Management Systems) need to evolve to merge existing tools, and improve operational and strategic decision assistance to Facility Managers, taking advantage from new updated and accurate information.
- To provide key updated and accurate information to every new or improved tool, a web based Data Hub must be developed in order to gather information from buildings models, existing buildings, Geographic Information Systems (Performance GIS), Performance BIM, IWMS (BMS, BEMS, CAFM etc.). Sustainable issues, Users necessities, Key Performance Indicators etc. to analyse this information, giving a hierarchical structure, identifying sensible

KPIs, providing short term and mid-term forecasts, and to send back to every new and improved tool the key data and KPIs needed to design and operate buildings in the best and most efficient way.

Finally, reference should be made to the need for innovation and the generation of new knowledge and new technologies to improve the performance and efficiency of existing equipment. For example, it is necessary to improve not only the integration of distributed generation into the Grid, but also intelligent metering systems, with prices that vary every minute depending, among other things, on the renewable generation available, demand side management (DSM) systems at the level of houses (BAS-Building Automation Systems and BACS-Building Automation and Control Systems), buildings (BEMS-Building Energy Management Systems), smart grid (supervisory control and data acquisition SCADA) to level demand and reduce energy peaks, electric energy storage systems (BESS - battery energy storage systems), both at building and district scales, using different technologies such as Solid-state batteries (SSB), or Flow batteries (FB) and the incorporation of electric cars with their batteries that can contribute and take advantage of the "consumption valleys", also contributing to levelling the demand for energy.

#### REFERENCES:

- [1] Aman, S., Simmhan, Y. & Prasanna, V.K., 2013. Energy management systems: state of the art and emerging trends. IEEE Communications Magazine, 51(1), pp.114–119.
- [2] Yehong Li, James O'Donnell, Raúl García-Castro, Sergio Vega-Sánchez. Enhancing energy management at district and building levels via an EM-KPI ontology. Automation in Construction Volume 99, March 2019, Pages 152-167
- [3] Yehong Li, James O'Donnell, Raúl García-Castro, Sergio Vega-Sánchez. Identifying stakeholders and key performance indicators for district and building energy performance analysis. Energy and Buildings 155 (2017) 1–15.

### **6.13. Demand side management (peak shaving)**

A large part of the energy consumed in buildings is electricity. Its provenance and ecological footprint depend on what the grid offers rather than on the preferences of the user. Electricity is usually produced in big plants, transported and distributed, and finally consumed. To make it cleaner, we need to intervene at three different levels:

Generation: The energy mix of sources generating electricity is mostly based in developed countries, on the combustion of gas, coal or oil-derived products, and/or from nuclear, hydroelectric, solar or wind power plants. Renewable sources are intermittent and we do not have many efficient electricity storage systems.

Transportation, transformation and distribution. Energy is very often produced far away from the location where it is consumed. Important losses and a significant amount of CO<sub>2</sub> emissions are associated with energy transportation and with its transformation.

The current trend is to focus on a distributed generation: the idea is to produce, so far as possible, most of the energy that is needed in the building itself, or in the district or the city where it is located, so that it does not need to be transported away. This type of energy production, however, tend to be more expensive and less reliable, and the challenge remains of how to integrate it into the network without it becomes unbalanced.

Consumption. We do not need only to reduce the electricity taken from the grid, but also to adjust as far as possible the demand to the production and vice versa. Nowadays, there are big differences in energy consumption between some particular time slots, and controlling and adapting them is difficult, since, for example, it takes a long time stopping and starting a nuclear power station, or we cannot be sure there will be wind or sun when we need it.

Balancing the demand and on adjusting the production to the demand are key challenges to level demand, reduce energy peaks (peaks shaving), and not oversize the power generation system and the grid. There is scope to use night hours, for example, for increasing the demand, by using household appliances, batteries or electric car recharges, etc. Figure 70 shows the electricity pattern consumption in Spain.

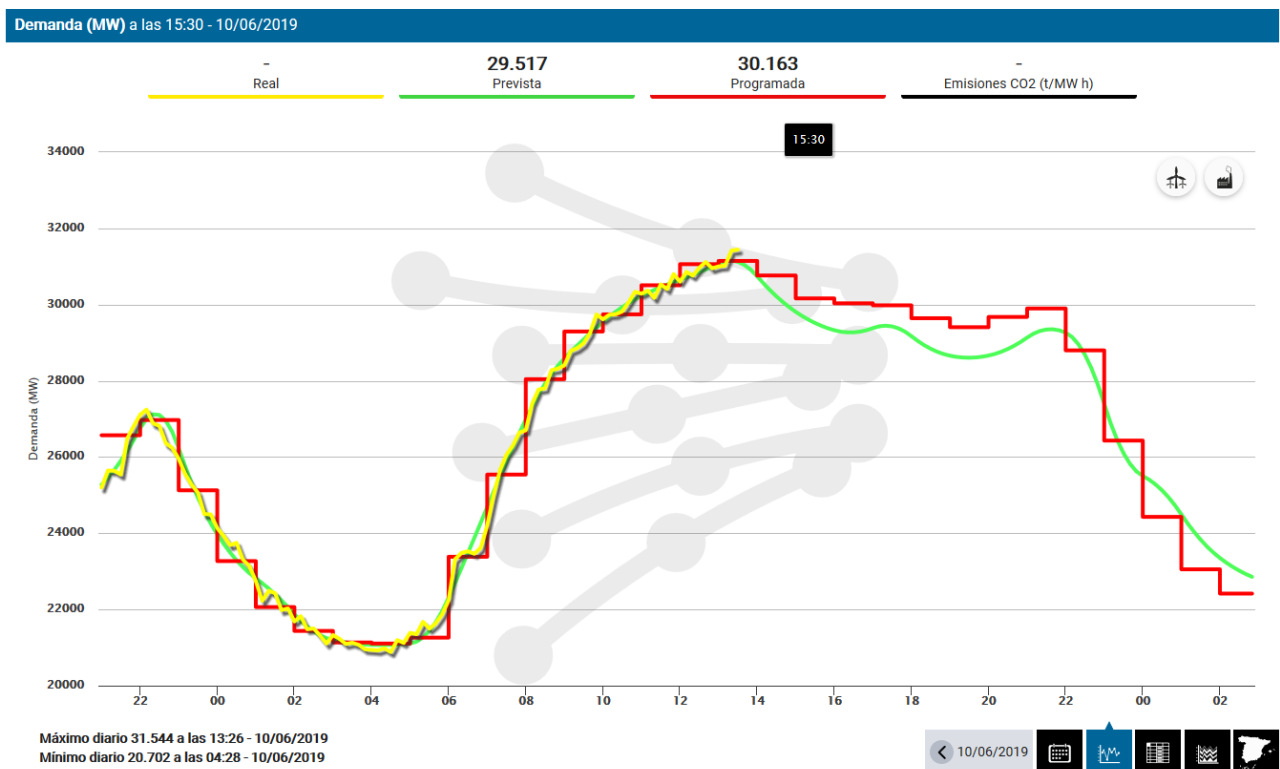

Figure 70. Electricity pattern consumption in Spain [5].



One key driver that could help in this challenge should be to approximate the electricity tariff to the real cost of energy production at any given time. Electricity pricing varies widely from country to country and may vary significantly from locality to locality within a particular country, and it changes on and on according to instant generation. Many factors go into determining an electricity tariff, such as the price of power generation, government subsidies, local weather patterns, transmission and distribution infrastructure and the share of renewable generation at that time, amongst others. Figure 71 shows data for Europe for European energy prices.

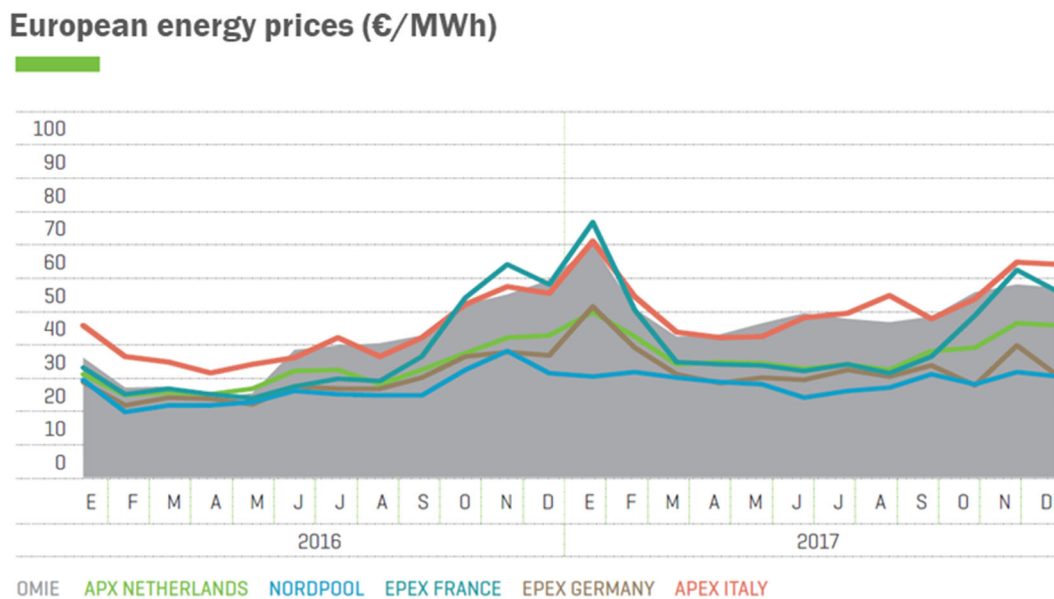

Figure 71. European energy prices.

Demand management becomes a key factor in levelling global energy demand and being able to meet more of the demand with existing production infrastructures, without needing to oversize them. Social awareness and role of users and Facility Managers are very important, as well as the development and improvement of multiple strategies and technologies such as the improvement of electric energy storage systems, the incorporation of electric cars with their batteries, demand side management systems (DMS) both at the level of each user and building (building energy management systems, demand side management systems, building automation and energy management systems etc.) as at the level of Smart Grids. All of these are some of the key drivers that should facilitate the improvement of the energy efficiency of the electrical system.

#### REFERENCES:

- [1] Yehong Li, James O'Donnell, Raúl García-Castro, Sergio Vega-Sánchez. Enhancing energy management at district and building levels via an EM-KPI ontology. Automation in Construction Volume 99, March 2019, Pages 152-167
- [2] Yehong Li, James O'Donnell, Raúl García-Castro, Sergio Vega-Sánchez. Identifying

stakeholders and key performance indicators for district and building energy performance analysis. *Energy and Buildings* 155 (2017) 1–15

[3] S. Vega et al. "SOLAR DECATHLON EUROPE 2010, Towards Energy Efficient Buildings". FGUPM, ISBN 978-84-15302-02-5, Madrid 2011

[4] Beatriz Arranz, Sergio Vega. Energy Balance Draft approach.

[5] <https://demanda.ree.es/visiona/peninsula/demanda/total/2019-06-10>

# 7. References

References are listed under individual chapters.

# **Appendix I – Datasheets on interdependencies, obstacles and success factors**

## CATEGORY

**WINDOWS STRATEGIES**

## TECHNICAL SOLUTION

**Windows replacement with high performance (low emissivity, triple/quadruple glazing,...)**

### COST-EFFECTIVENESS APPROACH

**TYPE OF STRATEGY:** Passive strategy oriented to save energy

**COST-ESTIMATION:** **IMPLEMENTATION:** High cost: thermal bridge break profiles, high performance glazing, cranes

**MAINTENANCE:** Low maintenance costs.

**OPERATION-CONSUMPTIONS:** Low. The better the performance, the lower the consumption

**EFFECTIVENESS:** **SAVINGS:** Very effective solution, for all kind of buildings.

**EFFICIENCY IMPROVEMENT:**

**ENERGY GENERATION:**

**CLIMATIC AREAS:** Effective for all European Climatic Areas, with a good strategy selection

**WHAT DEPENDS ON EFFECTIVENESS:** The performance of the windows must be adapted to the climatic and orientation needs of each building. If the selection of services is not adequate, the measure will not be cost-effective. Some examples:

- In cold weather and orientations, thermal bridge break profiles, PVC, triple or quadruple glazed windows, improve U-value and reduce heating loss. High performance windows are cost effective

- In warm climates and sun exposed orientations, good shading strategies and low emissivity glazing could be more cost effective than other high performance windows.

For big glazing surfaces in buildings, a good performance and cost effective selection becomes a key driver

### INTERDEPENDENCIES

**TYPE OF BUILDINGS** All kind of building with existing windows: residential, hospitals, hotels, offices, schools,...

### COMPLEMENTARY & INTERESTING COMBINATIONS

- You can replace old windows for new high performance units, or add new ones to existing windows

- In Mediterranean Climates with sun exposed orientations, shading is a needed strategy, and it can improve cost effectiveness of building retrofitting.

- Windows replacement is complementary with all possible envelopes strategies

- Solar Photovoltaics - BIPV : Sometimes, incorporation of PV panels could improve its cost effectiveness

- Solar Thermal Integration : Similar synergies could be obtained from Solar Thermal panels

- Better windows (U values) could generate condensation humidities on thermal bridges not adequately treated

### OBSTACLES / BARRIERS - ADVANTAGES

- Implementation of multiglazing units needs scaffolders, and/or cranes, as they are too heavy.

- It does need operate into the houses, so there could be some resistance from the neighbors

- It could need users to leave their homes, so again there could be resistance from some neighbors

- Windows replacement with high performance units improve energy efficiency and acoustic performance while retaining all other features of natural lighting, solar energy gains, appearance, etc.

- Air tightness will be typically improved, so complementary air ventilation strategies will be required

- It is not necessarily a good solution for historical buildings as it could alterate its image and could favour condensation humidities in thermal bridges not properly treated

### SUCCESS FACTORS

- The key success factor is the correct selection of its performance according to climate conditions and orientations

- Be sure there are no thermal bridges or low temperature surfaces in the room

- Define a good controlled air ventilation strategy preferred with heat recovery

- Neighborhood scale would lower the cost, improving cost - effectiveness

- Be sure recycled metals or sustainable PVC are used in order to reduce carbon print

**CATEGORY**

**INSULATION**

**TECHNICAL SOLUTION**

**ETICS (External Thermal Insulation Composite Systems)**

**COST-EFFECTIVENESS APPROACH**

**TYPE OF STRATEGY:** Passive strategy oriented to energy reduction and thermal comfort improvement

**COST-ESTIMATION:** **IMPLEMENTATION:** High cost of implementation: materials, finishing, scaffolders

**MAINTENANCE:** Low maintenance costs. It will depend of final surface finishes

**OPERATION-CONSUMPTIONS:** None or very low

**EFFECTIVENESS:** **SAVINGS:** Very effective solution, specially in buildings built previously to thermal regulation buildings

**EFFICIENCY IMPROVEMENT:** Up to 30% reduction in energy needs for heating and cooling

**ENERGY GENERATION:** n.a.

**CLIMATIC AREAS:** Effective for all European Climatic Areas

**WHAT DEPENDS ON EFFECTIVENESS:** Effective for all orientations, and for solid envelopes of all kind of buildings  
Cost-Effectiveness depend on insulation thickness

**INTERDEPENDENCIES**

**TYPE OF BUILDINGS** Especially used in residential buildings, but it could be used in all kind of buildings

**COMPLEMENTARY & INTERESTING COMBINATIONS**

- .- You can use same scaffolders and infrastructure to implement an ETICs solution and renovate windows or add new ones from the outside
- .- In Mediterranean Climates shading is a needed strategy, and to implement an ETICs solution you can share infrastructures as scaffolders reducing necessary costs and improving cost effectiveness of building retrofitting.
- .- The same for other envelope strategies that could share infrastructures to improve cost effectiveness.
- .- Versatility of finishes: It could be used with continuous reinforced rendering or any type of ventilated facades
- .- Solar Photovoltaics - BIPV : To share scaffolders could reduce costs in BIPV implementation improving its cost effectiveness
- .- Solar Thermal Integration : Similar synergies could be obtained from shared infrastructures.
- .- There are synergies with heating and cooling systems, influencing the dimensioning of such systems

**OBSTACLES / BARRIERS - ADVANTAGES**

- .- Implementation needs scaffolders
- .- Implementation is solely on the exterior of building envelope, so there is no need to cause disturbance to building users
- .- It does not need users to leave their homes, so again there will be less resistance from the neighbours
- .- Special attention must be paid to encounters with doors, windows, and other finishings
- .- Durability and its image will depend of the technical solution for the external finishing
- .- It is not a good solution for historical buildings as it alterates its image.

**SUCCESS FACTORS**

- .- Until the optimum insulation thickness is reached, the greater the thickness, the more cost-effective the solution.
- .- No thermal bridges
- .- Possibility of improving cost-effectiveness with an adequate industrialization
- .- Neighborhood scale would lower the cost, improving cost - effectiveness

## CATEGORY

**SOLAR GENERATION AND BIPV**

## TECHNICAL SOLUTION

**PV panels**

### COST-EFFECTIVENESS APPROACH

**TYPE OF STRATEGY:** Active strategy oriented to produce renewable energy through PV panels and its building integration (BIPV)

**COST-ESTIMATION:** **IMPLEMENTATION:** High cost: PV panels, arrays, electronics and BEMS, infrastructure for implementation

**MAINTENANCE:** Low maintenance costs. It will depend of Building Integration Photovoltaics (BIPV)

**OPERATION-CONSUMPTIONS:** None or very low

**EFFECTIVENESS:** **SAVINGS:**

**EFFICIENCY IMPROVEMENT:** Electronics and building energy management systems can levelled the demand and improve energy efficiency

**ENERGY GENERATION:** Cost effectiveness improving daily, according to technology used

**CLIMATIC AREAS:** In principle, it is effective for all climatic areas of Europe, but the more sunshine, the more production and the more cost effective it will be.

**WHAT DEPENDS ON EFFECTIVENESS:**

- The more solar radiation it receives, the more effective it becomes, so the orientations and inclinations of the panels are fundamental.
- Type of technology: mono-crystallin; multi-crystallin; thin film
- Other factors that affect its efficiency are the adequate ventilation of the trasdos, the cleaning of the panels, accidental patial shading, ...

### INTERDEPENDENCIES

**TYPE OF BUILDINGS** It could be used in all kind of buildings, but has more possibilities in single-user buildings such as offices, shopping malls, hotels, hospitals, residences, individual residential dwellings.

### COMPLEMENTARY & INTERESTING COMBINATIONS

The peak energy production does not usually meets the peak demand so:

- The efficiency of the system is improved if there is an intelligent demand management system.
- The efficiency is improved if it can be combined with a certain storage capacity of the system by means of batteries, electric car, or thermal energy storage
- Efficiency is improved if there is a communication system - interaction with nearby buildings at neighborhood level
- Distributed generation allows to consume the energy much close to production centers, reducing losses of energy because of transformation and transport.
- BIPV offers the possibility of using photovoltaic panels directly as constructive elements for facades and roofs, as one more architectural element with a high saving potential and new design possibilities.
- High potential of integrating existing Combined Heat and Power (CHP) plants with photovoltaic generation at district level.
- Self consumption of the produced electricity is often more economical than export.
- It can therefore be beneficial in combination with electric heating and cooling systems, such as heat pumps

### OBSTACLES / BARRIERS - ADVANTAGES

- Energy production is not continuous throughout the day and night, and its performance is subject to atmospheric weather
- Distributed generation can produce energy savings of up to 10% (due to losses due to transformation and transport), but it still has serious technological difficulties in levelling out and keeping the Grid stable.
- Efficient neighbourhood communication & integration management to reach Net Zero Energy Clusters is pending of development
- The impact of power companies and their influence on policy-makers, makes it difficult to implement the necessary regulatory changes and investments needed for the technological developments associated with distributed photovoltaic generation.
- The maintenance of clean panel surfaces is not easy to achieve, and results in significant performance losses.
- It is not a good solution for historical buildings as it is difficult to integrate without altering its image.
- New role for FM/users: PROSUMER, merging both roles of PRODUCERS and CONSUMERS. It requires education and training

### SUCCESS FACTORS

- The hierarchy of actions to optimize the cost effectiveness of an intervention involves saving the maximum amount of energy with passive systems, improving the efficiency of active systems, and the little energy that we still need to achieve with renewable energy. It is important to dimension the photovoltaic system to achieve net zero energy buildings (NZEB) or, better, Net Zero Energy Clusters (NZEC)
- BIPV must guarantee back ventilation and panel surfaces as cleaned as possible, as well as improving the image of the building by perceiving the panels as part of the design of the building, and not as a mere addition to it.
- Possibility of improving cost-effectiveness with an adequate electronics and building energy management systems
- Neighborhood scale would lower the cost and improve interaction to reach NZEC, getting better cost - effectiveness

**CATEGORY**

**ENERGY MANAGEMENT**

**TECHNICAL SOLUTION**

**Building automation systems (BAS)/ Building Energy Management Systems (BEMS)**

**COST-EFFECTIVENESS APPROACH**

**TYPE OF STRATEGY:** Active strategy to monitor and control the demand through Building Energy Management Systems (BEMS)

**COST-ESTIMATION:** **IMPLEMENTATION:** Medium cost to monitorize building energy performance plus the BEMS to operate it

**MAINTENANCE:** Low maintenance costs. It will depend of the robustness of monitoring system.

**OPERATION-CONSUMPTIONS:** It needs dedicated Facility Management resources to analyze periodically

**EFFECTIVENESS:** **SAVINGS:**

**EFFICIENCY IMPROVEMENT:** Building monitoring, control, and Building Energy Management Systems can levelled the demand and improve energy efficiency

**ENERGY GENERATION:**

**CLIMATIC AREAS:** It is effective for all climatic areas of Europe

**WHAT DEPENDS ON EFFECTIVENESS:**

- The efficiency of the BAS / BEMS systems depends on the level of monitoring of the building and the robustness of the management tool used.
- Specialized FM dedicated resources are key drivers for an effective energy management
- User's awareness and cooperation is another key driver for an effective energy optimization

**INTERDEPENDENCIES**

**TYPE OF BUILDINGS** It could be used in all kind of buildings, but has more possibilities in Facility Managers (FM) operated buildings such as offices, shopping malls, hotels, hospitals, residences,...

**COMPLEMENTARY & INTERESTING COMBINATIONS**

- BAS/BEMS systems have great potential to improve the energy efficiency of the building by integrating and optimizing monitoring and control systems, demand levelling, integration of renewable energies with accumulation capacity in batteries, electric cars, integration of energy management system at neighborhood/District scale,...
- BEMS systems have great potential to improve the energy efficiency not only of the building with their solar thermal and photovoltaic systems, but globally, exchanging information and interacting with other buildings at district level, with their energy systems, and with district heating and cooling systems.
- Internet of Things (IoT) can improve daily operation of buildings and can commit users to a more sustainable use of energy

**OBSTACLES / BARRIERS - ADVANTAGES**

- BAS / BEMS must work with open protocols to be fully integrated into FM building operation tools as CAFM (Computer Aided Facility Management), IWMS (Integrated Workplace Management Systems), or BMS (Building Management Systems)
- Facility Managers have to be trained into energy efficiency strategies and into Building Energy Management Systems operation
- There are technical barriers yet with the relationship among different building's BEMS, and with district heating&cooling Systems, Utilities's Grids,...
- The impact of power companies and their influence on policy-makers, makes it difficult to implement the necessary regulatory changes and investments needed for the technological developments associated with distributed generation and energy exchange.
- User's awareness and collaboration is needed to save energy, so it is important to incorporate to the BEMS. IoT could collaborate in users awareness and local management, but systems have to be developed yet.
- For new buildings the systems must be integrated with wiring systems (cheaper and safer), but radio or wifi technologies must also be developed for implementation in existing buildings

**SUCCESS FACTORS**

- Enough-optimized level of monitoring to control and operate all the energy issues of the building and its spaces. Neither little information that would be insufficient for efficient energy management, nor excess monitoring that would generate unnecessary cost overruns and data overload.
- Robust software and building operation system that is interoperable with the main tools used by FM for building operation: CAFM (Computer Aided Facility Management), IWMS (Integrated Workplace Management Systems), BMS (Building Management Systems)...
- Educated and trained Facility Managers, or specialized resources to operate buildings with adequate strategies and with full use of the potential provided by BAS/BEMS
- Another key driver is user's awareness, commitment, and collaboration to save energy, using properly their workplaces.



CATEGORY

**DISTRICT HEATING & DISTRICT COOLING**

TECHNICAL SOLUTION

**Low-temperature thermal grids - LLTG**

COST-EFFECTIVENESS APPROACH

- TYPE OF STRATEGY: Low temperature district heating systems or Grids, with at least, the minimum temperature necessary for domestic hot water (50-70°C) although could be working with lower temperatures, as Cold District Heating systems (below 35°C).
- COST-ESTIMATION: IMPLEMENTATION: Lower cost of implementation and running than normal District Heating infrastructure as it is cheaper due to reduced requirements to insulation and it is easier to produce lower temperature from renewable energies, Geothermal Heat Pumps, or waste energy, and because there will be lesser energy losses.
- MAINTENANCE: Maintenance costs will depend mostly on the energy production systems, cheaper for Geothermal heat pumps or renewable thermal energy, and more expensive for Air-water heat pumps, gas boilers, ...
- OPERATION-CONSUMPTIONS: Low consumption for thermal solar energy, Geothermal Heat Pumps, something more for air-water heat pumps, and much more for gas, or fuel boilers.
- EFFECTIVENESS: SAVINGS:
- EFFICIENCY IMPROVEMENT: COP's of compression chillers based in Geothermal Heat Pumps are around 5-6, very efficient technology. COPs for Air-Water are lower, around 3-4
- ENERGY GENERATION:
- CLIMATIC AREAS: As cooling systems, are only effective for Mediterranean and warm continental climates (south Europe)
- WHAT DEPENDS ON EFFECTIVENESS:
  - Effectiveness depends on the machine and strategy used to produce heat, or recover heat from industrial processes, and in the losses of the Grid. The lower temperature, the lower losses.
  - Effectiveness for Cold District Heating systems depends on efficiency of decentralised heat pumps ("booster units") needed to ensure a corresponding increase in temperature for users.

INTERDEPENDENCIES

TYPE OF BUILDINGS Especially used in all kind of buildings, both, residential and not residential

COMPLEMENTARY & INTERESTING COMBINATIONS

- One of the key drivers for a cost-effective district heating system based in LLTG is the integration of renewable energy sources, o geothermal heat pumps.
- Low temperature in building heating systems and high temperature cooling systems fits better with LLTG.
- There are interesting experiences about district heating networks, in which there may be a large district heating infrastructure producing energy at high temperatures (70-80°C), to which other small district heating networks are connected, that serve a few buildings at a lower temperature (20°C), adjusting the temperature in each building with efficient heat pumps.
- Energy efficiency from District Heating infrastructures can be improved through Energy Management Systems (EMS) that include exchange information with local Building Energy Management Systems (BEMS) and other FM operating tools (CAFM, IWMS, BMS,...)

OBSTACLES / BARRIERS - ADVANTAGES

- Advantages of this LLTG strategy are it is cheaper and easier to produce lower temperature from renewable energies, Geothermal Heat Pumps, or wasting energy, and there will be lesser energy losses.
- Low temperature district heating systems will probably produce a lesser impact in its environment, as low temperature is easier to produce from renewable energies and geothermal heat pumps, or take advantage from industrial residual energy losses.
- Low temperature district heating systems (LLTG) (50°C-70°C) can be efficient for heating purposes and DHW, but is not useful for cooling supply, while Cold District Heating and cooling networks can be effective in both needs.
- The technology of LLTG and Cold District Heatings/coolings are known, but they are not very widely neither used, nor tested yet. Research and in depth case studies must be analysed to verify its cost-effectiveness and in which conditions.

SUCCESS FACTORS

- Cost -Effectiveness of LLTG and Cold District heating/cooling comes from the integration of renewable energy sources, o geothermal heat pumps, or industries waste energies. And also in low temperature heating and high temperature cooling systems in buildings.
- Energy Management Systems (EMS) that include exchange information with local Building Energy Management Systems (BEMS) is a key driver

**CATEGORY**

**DISTRICT HEATING & DISTRICT COOLING**

**TECHNICAL SOLUTION**

**Cogeneration**

**COST-EFFECTIVENESS APPROACH**

**TYPE OF STRATEGY:** The cogeneration using internal combustion engines operating according to the Otto cycle (1) (petrol gas, biofuel) and the Diesel cycle (2) (diesel and biodiesel), producing electricity and recovery heat from the process, that typically needs the support of auxiliary boilers and systems accumulation. Organic Rankine Cycle (ORC) systems (3) cogenerates from biomass, geothermal, solar energy, industrial waste heat recovery,... converting heat into work (electricity). Other existing technologies are Stirling engines (4), steam cycle (5), and combined cycle (6).

**COST-ESTIMATION: IMPLEMENTATION:** Very High cost of implementation because the needed infrastructures, depending on the technology and its capacity.

**MAINTENANCE:** High maintenance costs, specially for bigger installations

**OPERATION-CONSUMPTIONS:** Low - medium consumption according to the technologies used

**EFFECTIVENESS: SAVINGS:**

**EFFICIENCY IMPROVEMENT:** Efficiency of cogeneration systems depends on the technology used, and some of them are not too effective.

**ENERGY GENERATION:** The cogeneration, with different proportion according to different technologies, produces both, heat and electricity.

**CLIMATIC AREAS:** Most of the technologies are available for climatic conditions. Some such as solar ORC (3) (4) (5) or (6) work better in warm climates

**WHAT DEPENDS ON EFFECTIVENESS:** - Effectiveness of ORC (3) systems is much bigger than (1) or (2). ORC is the most cost-effective sustainable energy generation in district cogeneration plants, and almost 75% of all ORC installed capacity in the world, power generation comes from geothermal brines

- Each technology has its advantages and disadvantages and the cost effectiveness comes from a good choice of the system and sources used.

- Because of the very high cost of these type of power plants, cost effectiveness is easier to reach with bigger plants, but depends on a good strategy selection.

**INTERDEPENDENCIES**

**TYPE OF BUILDINGS** Cogeneration Plants linked to District Heating and cooling systems are adequate for all kind of buildings, both, residential and not residential

**COMPLEMENTARY & INTERESTING COMBINATIONS**

- Using Biomass to feed ORC systems produces an overall efficiency of 88%: around 18% of electricity, and around 70% of hot water (90°C)

- Low-temperature geothermal ORC plants (80-150°C) have high auxiliary consumption, and it is not too interesting. Higher temperatures (>150°C) provides heat for low temperature District heating, as well as electricity (with low efficiency).

- Industrial waste heat recovery ORC systems mitigates pollution, and can both, generate electricity and reuse the remaining heat.

- Concentrating solar power plants with very high temperature, works better with Stirling engines (for small-scale plants), and the steam cycle, or even the combined cycle (for solar towers).

- Energy efficiency from District Heating infrastructures can be improved through Energy Management Systems (EMS) that include exchange information with local Building Energy Management Systems (BEMS) and other FM operating tools (CAFM, IWMS, BMS,...)

**OBSTACLES / BARRIERS - ADVANTAGES**

- The main problem comes from the project Finance and higher investments needed to implement an effective District Heating infrastructure based in Cogeneration plants

- Cogeneration plants reach high electrical yields, from 20-25% of the machines from a few tens of kW to 40% and more for the different engines hundreds of kW

- Most of these systems keep up rather high emissions of all the major macro-pollutants of regulatory interest, specially (1) and (2) technologies, but not only.

- There are many innovative fuels useful for some of the ORC technologies as bio-gas, ethanol, bio-diesel, vegetable oils, oils deriving from processes industrial, processing of organic substances, oils from animal fats, used cooking oils, etc

- ORC with solar applications is too expensive and so, less cost effective than other cogenerations options or, even PV panels with battery systems.

**SUCCESS FACTORS**

- Usually the bigger plants, the most cost effective. So according to real necessities, it must be defined which strategies and technologies are the most suitable for each case, studying them in terms of optimal cost effectiveness.

- Energy Management Systems (EMS) that include exchange information with local Building Energy Management Systems (BEMS) can be a key driver

## CATEGORY

**INDOOR AIR CONDITIONING OF BUILDINGS**

## TECHNICAL SOLUTION

**Passive strategies and cheap free cooling systems**

### COST-EFFECTIVENESS APPROACH

- TYPE OF STRATEGY:** Passive strategies oriented to cheap free cooling systems: (1) Night ventilation strategies and accumulation, or (2) pre-cooling systems with buried channels, (3) solar chimneys, (4) Evaporative cooling
- COST-ESTIMATION:** **IMPLEMENTATION:** High cost of implementation if we use buried channels (2) or evaporative cooling (4), lower for solar chimneys (3), and cheaper for night ventilation (1)
- MAINTENANCE:** Low maintenance costs
- OPERATION-CONSUMPTIONS:** None or very low
- EFFECTIVENESS:** **SAVINGS:** Very effective and cheap solution to reduce needs of cooling in warm weathers
- EFFICIENCY IMPROVEMENT:**
- ENERGY GENERATION:**
- CLIMATIC AREAS:** Effective for Mediterranean and warm continental climates (south Europe)
- WHAT DEPENDS ON EFFECTIVENESS:**
- .- Effectiveness for (1) depends on enough night cooling and good thermal inertia
  - .- Effectiveness for (2) depends on sufficient depth and length of buried ducts
  - .- Effectiveness for (3) depends on design of the solar chimney and sufficient volume of sanitary chambers (under the building) or buried ducts
  - .- Effectiveness for (4) depends mainly on the humidity level of the environment, and on the system of nebulization or design of the utilized equipment

### INTERDEPENDENCIES

**TYPE OF BUILDINGS** Especially used in residential buildings, but it could be used in all kind of buildings

#### COMPLEMENTARY & INTERESTING COMBINATIONS

- .- You can use all these strategies to reduce daily internal temperature, saving energy by reducing the temperature differential needed to provide adequate comfort conditions
- .- It is interested, specially for night ventilation strategies (1) to take advantage from thermal inertia.
- .- Phase Change Materials (PCMs) can be used not only to save energy by making use of its storage capacity, but also, if the phase change temperature is properly selected, to mitigate thermal variations and thus reduce the temperature differential needed to provide adequate comfort conditions.
- .- It is complementary with active HVAC systems based on the compression refrigerator, or absorption technologies
- .- Evaporative cooling (4) can take advantage of ventilating fans, improving the subjective cooling perception.
- .- Shading elements on façades, especially in glazed areas, reduce solar radiation gains and allow passive cooling measures to be sufficient longer without the need for mechanical support.
- .- Building Energy Management Systems and FM operating tools (CAFM, IWMS, BMS,...) can help with the optimal use of these strategies.

### OBSTACLES / BARRIERS - ADVANTAGES

- .- None of these measures is sufficiently effective without mechanical support if the building is heavily exposed to solar radiation, especially in glazed areas
- .- (2) and (3) needs infrastructure that must be connected to controlled ventilation systems
- .- (1) in residential buildings needs users collaboration that must know how to take advantage of night cooling
- .- (1) in other type of buildings they needs infrastructure integrated to HVAC systems to take advantage of night cooling, FM training, and control systems to operate them
- .- (1) strategy is a good solution for cooling historical buildings as they use to have heavy thermal inertia. (4) strategy could be a good complementary strategy for small spaces.

### SUCCESS FACTORS

- .- Each strategy meets the conditions necessary for it to be effective, as described above
- .- Shading control of direct sun radiation in glazed areas
- .- Educated and trained Facility Managers, or specialized resources to operate buildings with adequate strategies
- .- Another key driver is user's awareness and commitment to save energy, using properly their houses and workplaces.

**CATEGORY**

**INDOOR AIR CONDITIONING OF BUILDINGS**

**TECHNICAL SOLUTION**

**Active HVAC systems through cooling machines**

**COST-EFFECTIVENESS APPROACH**

- TYPE OF STRATEGY:** Active HVAC oriented to efficient cooling systems: (1) Conventional Heat pumps, (2) geothermal heat pumps, or (3) Absorption chillers
- COST-ESTIMATION:**
- IMPLEMENTATION:** High cost of implementation if we use geothermal heat pumps (2) (because needed infrastructure) or Absorption chillers (3) (these chillers are expensive). Conventional heat pumps are cheaper.
- MAINTENANCE:** Medium maintenance costs, (3) lower than systems based in compression refrigerator
- OPERATION-CONSUMPTIONS:** Higher consumption for (1), Medium for (2), and much lower for (3)
- EFFECTIVENESS:**
- SAVINGS:**
- Efficiency is very variable depending on the technology used: COP's of compression chillers (1) are between 3-4, for (2) are around 5-6, and for (3) are around 0,7 (for single effect LiBr machines) and 1,2 (double-effect chillers)
- EFFICIENCY IMPROVEMENT:**
- ENERGY GENERATION:**
- CLIMATIC AREAS:** As cooling systems, are only effective for Mediterranean and warm continental climates (south Europe)
- WHAT DEPENDS ON EFFECTIVENESS:**
- Effectiveness for (1) depends on the equipment and the heat sink (air or water). The lower is the temperature of sink, the better efficiency of the machine during summer
  - Effectiveness for (2) depends on the machine, and as the ground act as sink, the deeper infrastructure, the better, as its more estable and cooler in summer
  - Effectiveness for (3) depends mainly on the higher temperature of the heat source, connected to solar thermal panels, cogeneration systems, district heating systems,...

**INTERDEPENDENCIES**

**TYPE OF BUILDINGS** Especially used in all kind of buildings, both, residential and not residential

**COMPLEMENTARY & INTERESTING COMBINATIONS**

- The best possibility for new buildings to improve energy efficiency from HVAC systems, is through (2) geothermal heat pumps, specially if it has deep foundations with piles, or if you have more than one basement and containment systems are through screens or piles, in which case the cost of infrastructure is greatly reduced, enhancing the cost effectiveness of the strategy
- The existence of large bodies of water nearby such as lakes, sea, groundwater levels, ... can also favour similar cost-effective systems (2)
- Absorption systems (3) can take advantage of residual heating in cogeneration power plants during summer, as well as of district heating facilities.
- Absorption systems (3) can get free heat from solar thermal panels, which can provide water with 100°C
- Energy efficiency from all these strategies can be improved through Building Energy Management Systems (BEMS) and other FM operating tools (CAFM, IWMS, BMS,...)
- Energy efficiency from all these strategies can be improved as well through incorporation of free cooling systems and other passive cooling approaches

**OBSTACLES / BARRIERS - ADVANTAGES**

- All these technologies are expensive if the building is heavily exposed to solar radiation, especially in glazed areas, so investment in shading elements and insulation are key drivers for successful and efficient performance
- Geothermal heat pumps(2) are very difficult and expensive to implement in existing buildings, and for sure, in historical buildings
- Geothermal heat pumps(2) are expensive to implement in superficial foundation buildings, and cost-effectiveness has to be studied for every building.
- Absorption chillers (3), because of its higher costs (double) and very low efficiency (COP below 1) it does not meet a cost effective strategy, so it has to be analyzed in every case. Residual heating from industry, cogeneration plants, big thermal solar panels, or usage of district heating plants could help in its cost-effectiveness

**SUCCESS FACTORS**

- Each strategy meets the conditions necessary for it to be effective, as described above
- Shading control of direct sun radiation in glazed areas and insulation are key drivers for successful global strategies
- Educated and trained Facility Managers, or specialized resources to operate buildings with adequate strategies

## CATEGORY

**DISTRICT HEATING & DISTRICT COOLING**

## TECHNICAL SOLUTION

**Ground, water and air source heat pumps connected to district heating**

## COST-EFFECTIVENESS APPROACH

- TYPE OF STRATEGY:** District Heating and District Cooling systems based in Geothermal Heat Pumps: Ground source heat pumps (1), or water source, or water-water, heat pumps (2). A third used option are air-water heat pumps (3)
- COST-ESTIMATION: IMPLEMENTATION:** Geothermal ground heat pumps and distribution grids have very high cost of implementation because of the needed infrastructure for the boreholes (energy wells), and somewhat lower costs for horizontal ground systems. The price for geothermal water heat pumps (2), for sea, lake and groundwater loops are also high. Air-Water heat pumps (3) carry a lower investment cost because they need a little less infrastructure, but have lower efficiency.
- MAINTENANCE:** Low maintenance costs for Geothermal units (1) (2), and somewhat higher for air-water units (3). Lifespan of air-water units (3) is around 15 years, and around 20 years to 25 years for (1) or (2),
- OPERATION-CONSUMPTIONS:** Low consumption for geothermal heat pumps (1) (2), and somewhat more for air-water heat pumps (3), but all of them are much cheaper than gas boilers or electric heating.
- EFFECTIVENESS: SAVINGS:**
- EFFICIENCY IMPROVEMENT:** COP's of compression chillers based in Geothermal Heat Pumps are around 5-6, very efficient technology. COPs for Air-Water are lower, around 3-4. In very cold climates COPs for (1) or (2) is around 4, and around 2-3 for (3)
- ENERGY GENERATION:**
- CLIMATIC AREAS:** All European climates but they are less efficient in very cold climates.
- WHAT DEPENDS ON EFFECTIVENESS:**
- Effectiveness depends on the machine and on the temperature levels. As the ground act as a sink, the deeper the infrastructure is, the higher the efficiency is, as it is more stable, i.e. cooler in summer and warmer in winter.
  - Effectiveness for Air-water (3) (or water-water) heat pumps depends on the equipment and the heat sink (air or water). The lower the temperature is of the sink, the worse is the efficiency of the machine. Below -10°C to -20°C extra heating must be added.
  - To achieve high effectiveness for the medium and big District Heating Plants with air-water (3) heat pumps, needing many different units, is better to make the connection "in parallel" than "in series", but then the control strategy becomes more complex.
  - Effectiveness is better in low temperature district heating systems.

## INTERDEPENDENCIES

**TYPE OF BUILDINGS** Used in all kinds of buildings, both residential and non-residential

### COMPLEMENTARY & INTERESTING COMBINATIONS

- One of the key drivers for a cost-effective district heating system based on geothermal heat pumps is the number and depth of boreholes (energy wells) - better than horizontal ground loops or sea, lake, groundwater loops. So it is important to carry out geotechnical studies that allow a good selection of the site, so that cost-effectiveness is not jeopardized.
- The existence of large bodies of water nearby such as lakes, sea, or groundwater, can also favour cost-effective systems, as they are much cheaper than deep vertical ground systems.
- Energy efficiency from District Heating infrastructures based in air-water heat pumps is worse in very cold climates, and complementary heat sources are needed, with less cost-effectiveness. Taking advantage of the heat from exhaust ventilation air (exhaust air heat pump) in buildings is interesting.
- Energy efficiency from District Heating infrastructures can be improved through Energy Management Systems (EMS) that include exchange information with local Building Energy Management Systems (BEMS)
- A promising experience is called ectogrid™, consisting on combining a District thermal grid for both heating and cooling, based on heat pumps, with a system which circulate, reuse and share the energy of buildings that are balanced against each other within a district, saving energy and costs. (The world's first ectogrid™ is available at Medicon Village in Lund, Sweden)

## OBSTACLES / BARRIERS - ADVANTAGES

- The main problem comes from the project Finance and the higher investments needed to implement an effective District Heating infrastructure based on Geothermal Heat Pumps (1) (2). Air-Water heat pumps (3) are cheaper because they need a little less infrastructure, but they have lower efficiency.
- Geotechnical characteristics of the soil are decisive for the cost and efficiency of this type of heat exchange, necessary for a better performance of the geothermal heat pump, therefore the choice of location can be critical from the point of view of economic viability and cost-effectiveness
- District Heating with geothermal heat pumps have low environmental impact as most of the infrastructure is invisible, silent technologies, and very low impact in the ground, fauna and flora. They have lower exploitation costs than air-source heat pumps (3), which are noisy. Leakages of refrigerants, is an environmental risk to be eliminated in all of them.
- Cost Efficiency of District Heating with Heat Pumps vary according with climate conditions and local energy costs. Probably, although COPs are smaller, in colder climate conditions and more expensive energy markets makes this option more cost-effective, while not too attractive (cost effective) in warmer climates and cheaper energy markets. Selection of the heat sources must be studied always according with its cost-effectiveness

## SUCCESS FACTORS

- Deep borehole geothermal heat pumps are more efficient than horizontal loop ground and water source systems
- Energy Management Systems (EMS) that include exchange information with local Building Energy Management Systems (BEMS) is a key driver

## CATEGORY

**SOLAR GENERATION AND INTEGRATION**

## TECHNICAL SOLUTION

**Solar Thermal Systems**

### COST-EFFECTIVENESS APPROACH

- TYPE OF STRATEGY:** Active strategy to produce from solar thermal panels, space heating and Domestic Hot water (DHW). (Big Solar Thermal plants excluded)
- COST-ESTIMATION:** **IMPLEMENTATION:** Medium cost from Solar thermal panels and infrastructure for implementation  
**MAINTENANCE:** Low maintenance costs.  
**OPERATION-CONSUMPTIONS:** None or very low. Operating costs around 1.5%/year of the initial investment.
- EFFECTIVENESS:** **SAVINGS:**  
**EFFICIENCY IMPROVEMENT:**
- ENERGY GENERATION:** Cost effective technology to generate free thermal energy as primary source to reduce the energy needed to produce heated water for DHW or building heating.
- CLIMATIC AREAS:** In principle, it is effective for all climatic areas of Europe, but heat production and cost effectiveness are dependent on solar radiation availability.
- WHAT DEPENDS ON EFFECTIVENESS:**
- The more solar radiation it receives, the more effective it becomes, so the orientations and inclinations of the panels are fundamental.
  - Type of effective technologies: flat plate collectors, vacuum tubes collectors, vacuum panels
  - Other factors that affect its efficiency are the adequate insulation of the whole installation and the efficiency of the exchanger.

### INTERDEPENDENCIES

**TYPE OF BUILDINGS** It could be used in both, residential and not residential buildings.

### COMPLEMENTARY & INTERESTING COMBINATIONS

- In many Mediterranean countries building regulations require the provision of solar thermal panels in buildings, providing a high percentage of the needs for DHW.
- In single-family houses in temperate climates, with a good design and dimensioning of the solar thermal system, a very high percentage of DHW can be achieved, and substantial savings can be gained by using it as the primary heating system, reducing the thermal contribution necessary to maintain the house in comfortable conditions.
- In these single-family houses in temperate climates, with the surplus of thermal energy produced in summer, "solar cooling" can be produced by absorption machines, also reducing the need for energy supply.
- Similar potential could be obtained for District Heating and District Cooling infrastructures
- Integration of these strategies into Building Energy Management Systems (BEMS) is a key driver to become cost effective.
- Synergies with transparent insulation materials and solar façades integration can provide innovative solutions

### OBSTACLES / BARRIERS - ADVANTAGES

- Energy production is not continuous throughout the day and night, and its performance is subject to atmospheric weather, with very high seasonal fluctuations.
- This renewable support does not obviate the need for complete thermal installations with your gas boilers, heat pumps, etc. The advantage is that it saves a good part of the consumption of gas and electricity later.
- Day/night energy storage is easy to achieve. The energetic accumulation of several days chained with/without sun, requires more volume and cost, but it is equally possible. Seasonal energy banking is not resolved efficiently, so the cost-effectiveness of this strategy is limited.
- Identified constraints in historical buildings as it is difficult to integrate without altering its image.
- Implementation face a number of barriers, such as lack of information/Know-How, and economic and technical issues

### SUCCESS FACTORS

- The cost effectiveness depends on the climate, and according to the climatic conditions, the design and size of the solar thermal system can be oriented as the primary contribution of DHW, or it can also include the primary contribution of the heating system. In warmer climates, the strategy could include the production of "solar cooling" through absorption machines.
- The use of large-scale solar thermal energy through District heating&cooling infrastructures (and its cost effectiveness) can largely benefit from the performance improvement of seasonal storage systems.
- Educate and train Facility Managers, or specialized resources to operate buildings with this technology is important
- Another key driver is user's awareness, commitment, and collaboration to save energy, using properly this strategy

**CATEGORY**
**SOLAR GENERATION AND BIPV**
**TECHNICAL SOLUTION**
**Photovoltaics & thermal hybrid solar collectors (PVT)**
**COST-EFFECTIVENESS APPROACH**

- Active strategy oriented to produce renewable energy through PV panels and its building integration (BIPVT), taking advantage of the solar heat produced in PV cells, and recovering through the air for warm building ventilation, or through water to support space heating and Domestic Hot water (DHW).
- TYPE OF STRATEGY:** Advantage of the solar heat produced in PV cells, and recovering through the air for warm building ventilation, or through water to support space heating and Domestic Hot water (DHW).
- COST-ESTIMATION:** **IMPLEMENTATION:** High cost: PV panels, arrays, electronics and BEMS, infrastructure for implementation
- MAINTENANCE:** Medium maintenance costs. It will depend of Building Integration Photovoltaics (BIPV), and the hybrid technology used
- OPERATION-CONSUMPTIONS:** None or very low
- EFFECTIVENESS:** **SAVINGS:**
- EFFICIENCY IMPROVEMENT:** Electronics and building energy management systems can levelled the demand and improve energy efficiency
- ENERGY GENERATION:** Cost effectiveness improving daily, according to technology used
- CLIMATIC AREAS:** In principle, it is effective for all climatic areas of Europe, but the more sunshine, the more production and the more cost effective it will be.
- WHAT DEPENDS ON EFFECTIVENESS:**
- The more solar radiation it receives, the more effective it becomes, so the orientations and inclinations of the panels are fundamental.
  - Type of technology for the PV cells: mono crystallin; multi-crystallin; thin film. Type of hybrid technology to cool and absorb heat: water or air
  - Other factors that affect its efficiency are the lower fluid temperature, cleaning of the panels, accidental shading, adequate insulation of the whole installation, and the efficiency of the exchanger.

**INTERDEPENDENCIES**

- TYPE OF BUILDINGS** It could be used in all kind of buildings, but has more possibilities in single-user buildings such as offices, shopping malls, hotels, hospitals, residences, individual residential dwellings.

**COMPLEMENTARY & INTERESTING COMBINATIONS**

The peak energy production does not usually meets the peak demand so:

- The efficiency of the system is improved if there is an intelligent demand management system.
- The efficiency is improved if it can be combined with a certain storage capacity of the system by means of batteries, electric car,...
- Efficiency is improved if there is a communication system - interaction with nearby buildings at neighborhood level
- Distributed generation allows to consume the energy much close to production centers, reducing losses of energy because of transformation and transport.
- BIPVT offers the possibility of using photovoltaic-thermal panels directly as constructive elements for facades and roofs, as one more architectural element with a high saving potential and new design possibilities.
- In single-family houses in temperate climates, with an adequate number of complementary solar thermal panels, a very high percentage of DHW can be achieved, and substantial savings can be gained by using it as the primary heating system, reducing the thermal contribution necessary to maintain the house in comfortable conditions. Further, with the surplus of thermal energy produced in summer, can be produced "solar cooling" by absorption machines, also reducing the need for energy supply. But not only with hybrid PVT panels.
- Photovoltaics and Thermal hybrid collectors can provide another cost-effective strategy based on heat pump units, both, at building and district scales.
- Photovoltaics and Thermal hybrid collectors and its linked infrastructure are more technically complex and expensive, so cost effectiveness must be carefully analyzed for every case.

**OBSTACLES / BARRIERS - ADVANTAGES**

- Energy production is not continuous throughout the day and night, and its performance is subject to atmospheric weather
- Distributed generation can produce energy savings of up to 10% (due to losses due to transformation and transport), but it still has serious technological difficulties in levelling out and keeping the Grid stable.
- Efficient neighborhood communication & integration management to reach Net Zero Energy Clusters is pending of development
- The impact of power companies and their influence on policy-makers, makes it difficult to implement the necessary regulatory changes and investments needed for the technological developments associated with distributed photovoltaic generation.
- The maintenance of clean panel surfaces is not easy to achieve, and results in significant performance losses.
- It is not a good solution for historical buildings as it is difficult to integrate without changing its image.
- New role for FM/users: PROSUMER, merging both roles of PRODUCERS and CONSUMERS. It requires education and training

**SUCCESS FACTORS**

- The hierarchy of actions to optimize the cost effectiveness of an intervention involves saving the maximum amount of energy with passive systems, improving the efficiency of active systems, and the little energy that we still need to achieve with renewable energy. It is important to dimension the photovoltaic and thermal systems to achieve net zero energy buildings (NZEB) or, better, Net Zero Energy Clusters (NZEC)
- BIPVT must guarantee panel surfaces as cleaned as possible, as well as improving the image of the building by perceiving the panels as part of the design of the building, and not as a mere addition to it.
- Possibility of improving cost-effectiveness with an adequate electronics and building energy management systems (BEMS)
- Neighborhood scale would lower the cost and improve interaction to reach NZEC, getting better cost - effectiveness

**CATEGORY**

**ENERGY STORAGE**

**TECHNICAL SOLUTION**

**Thermal Energy Storage (TES)**

**COST-EFFECTIVENESS APPROACH**

**TYPE OF STRATEGY:** Strategy for thermal storages using different principles for storing heat: sensible heat (1), latent heat storage (2), sorptive and chemical heat. (3 - thermochemical energy storages)

**COST-ESTIMATION:** **IMPLEMENTATION:** More or less expensive depending on the technology and material used for the storage, but specially (2) and (3) material are much higher than (1)

**MAINTENANCE:** Low maintenance costs.

**OPERATION-CONSUMPTIONS:** None or very low

**EFFECTIVENESS:** **SAVINGS:**

**EFFICIENCY IMPROVEMENT:** Efficient technologies for thermal storage could improve overall efficiency by taking advantage of waste energy from industrial processes, cogeneration processes, seasonal differences in solar thermal generation, etc.

**ENERGY GENERATION:**

**CLIMATIC AREAS:** In principle, it is effective for all climatic areas of Europe. If storage is for solar thermal energy, the more sunshine, the more production and the more cost effective it will be.

**WHAT DEPENDS ON EFFECTIVENESS:** .- Sensible heat (1) storage depends on the heat capacity of the storage material: water, ground,..., but big volumes are needed and they are not too effective

.- Latent thermal heat storages (2) depend on materials used for latent thermal heat stores: organic and inorganic phase change materials, and the temperature of phase change

.- Thermochemical heat storage (3) depends on the used principle of physical adhesion and absorption enthalpy, or chemical reaction enthalpy

.- Efficiency depends on the materials, size required, storage process, energy loading and unloading speed, storage period, and specially linked energy losses.

**INTERDEPENDENCIES**

**TYPE OF BUILDINGS** It could be used in all kind of buildings, both, residential and not residential buildings, but this technology has more sense for District infrastructures (in order to better cost-effectiveness)

**COMPLEMENTARY & INTERESTING COMBINATIONS**

.- Daily, weekly, and most of all, long term seasonal thermal energy storage are complementary to the production of solar thermal energy, especially for large district plants, or big residential buildings, hospitals, hotels, ...

.- Another interesting combination could be the use of the waste heat generated from industrial processes, from trigeneration or cogeneration processes, or, to a lesser extent, from other spaces or equipment such as CPD, heat pumps,...

.- Promising technology are the use of phase change materials (PCM) (2) and of thermochemical energy storages (TCM) (3), which allows smaller sizes of spaces as result of a much higher energy storage density (Up to 6 times TCM respect to water).

**OBSTACLES / BARRIERS - ADVANTAGES**

.- Despite the encouraging use of materials such as phase change materials (PCM) (2) and of thermochemical energy storages (TCM) (3), the limited experience in practical applications on a large scale, and the high investment cost that it represents, constitutes today a significant barrier.

.- Global cost effectiveness of these technologies is pending of being demonstrated. Experiences with sensible heat storage (1) are no cost effective enough, and using PCM (2) or TCM (3) are promising, but not tested on a large scale.

.- Research and testing plants are required to test these new storage materials

**SUCCESS FACTORS**

.- Future cost effectiveness depends on an enough good performance of new materials to store thermal energy (such as PCM (2) or TCM (3), to be tested), the development of faster and more efficient loading and unloading systems, a cheaper cost of these materials, and a certain scale allowing it to be combined, for example, with high-capacity solar thermal power plants

.- Energy Management Systems (EMS) that include exchange information with local Building Energy Management Systems (BEMS) will be a key driver



**CATEGORY**

**ENERGY STORAGE**

**TECHNICAL SOLUTION**

**Electrical Storage (ES)**

**COST-EFFECTIVENESS APPROACH**

**TYPE OF STRATEGY:** Strategy for electrical storages at building scale using different technologies such as Solid-state batteries (SSB), or Flow batteries (FB)

**COST-ESTIMATION:** **IMPLEMENTATION** Both technologies are expensive. FB are much higher, but the larger, the cheaper

**MAINTENANCE:** Low maintenance costs.

**OPERATION-CONSUMPTIONS:** None or very low

**EFFECTIVENESS:** **SAVINGS:** Save energy, because the conserve electricity that otherwise might have been lost.

**EFFICIENCY IMPROVEMENT:** Batteries are gradually improving their efficiency and over the last 10 years, they have improved their performance while significantly reducing costs. Even so, their efficiency, load speed, and durability must continue to improve in order to be truly competitive with other alternative energy strategies.

**ENERGY GENERATION:** n/a

**CLIMATIC AREAS:** In principle, it is effective for all climatic areas of Europe. If storage is for photovoltaics energy, the more sunshine, the more production and the more cost effective it will be.

**WHAT DEPENDS ON EFFECTIVENESS:**

- Solid state batteries have a much more energy density than FB, so are smaller and easier to install in residential buildings. High power in and out and suitable for short terms periods because of losses. Limited number of charge-discharge cycles.
- Flow batteries depends on electrolyte used and capacity and size on selected tank. Smaller energy density but allows long term storage without losses, and more than 10.000 charge-discharge cycles.

**INTERDEPENDENCIES**

**TYPE OF BUILDINGS** It could be used in all kind of buildings, both, residential and not residential buildings. SSB are mostly used for small buildings, and FB trend to be used in bigger ones and district infrastructures.

**COMPLEMENTARY & INTERESTING COMBINATIONS**

- The increased use of solid-state batteries (SSB) in small photovoltaic installations in single-family homes and small buildings, to give them a few days of autonomy influenced their progressive improvement of performance, volume and price reduction.
- The use of less intensive flow batteries, which require more space and are more expensive, but with a greater load capacity (due to their large volume) correspond to the use of photovoltaic installations in large buildings or in large district infrastructures.
- Both technologies could be used also for another renewable energy sources as wind.
- Positive synergies could be explored with other solar thermal strategies, heat pumps, etc, resulting in cost effective combinations.
- The cost effectiveness of these technologies for electric storage, may be increased with an efficient Building Energy Management System (BEMS) that allow to take advantage of all possible synergies among complementary strategies: Solar generation, management for demand levelling, energy exchange with nearby buildings or with the grid, decisions to store or take energy from one's own stored energy,...

**OBSTACLES / BARRIERS - ADVANTAGES**

- Hopefully the cheaper PV panels pushing the market to grow exponentially, will allow significant research developments, which will result in more efficient and cheaper electric energy storage systems - thus becoming more cost effective.
- Flow batteries (FB) technologies have many advantages, but they have to improve its energy density and become much more cheaper.
- Research and testing plants are required to test these new storage materials

**SUCCESS FACTORS**

- Future cost effectiveness depends on a sufficient performance of new technologies to store electric energy and lower cost of these materials.
- Energy Management Systems (EMS) that include exchange information with local Building Energy Management Systems (BEMS) will be a key driver

CATEGORY

**INDOOR AIR CONDITIONING OF BUILDINGS**

TECHNICAL SOLUTION

**Controlled ventilation with heat recovery**

**COST-EFFECTIVENESS APPROACH**

- TYPE OF STRATEGY:** Active strategy oriented to add heat recovery units to the ventilation system, either centralised (1) or decentralised for appartments (2) in order to save as much energy as possible, ensuring good air quality at all times (3)
- COST-ESTIMATION:** **IMPLEMENTATION:** Low (1) - Medium (2) cost of implementation as it consist of adding heat recovery units. Higher cost would have if monitorize CO<sub>2</sub> content in spaces and regulate the ventilation flow to maintain the desired levels of air quality, depending on the CO<sub>2</sub> content. (3)
- MAINTENANCE:** Low manteinance costs
- OPERATION-CONSUMPTIONS:** Very low
- EFFECTIVENESS:** **SAVINGS:** Very effective saving solution to reduce needs of heating / cooling in buildings as reduce the gap of temperature to be conditioned because of nedeed air renovation. If we also control the ventilation flow and adjust it according to the air quality (CO<sub>2</sub> level) of each room, or each apartment, the savings will be greater, while ensuring optimal air quality conditions all the time.
- EFFICIENCY IMPROVEMENT:**
- ENERGY GENERATION:**
- CLIMATIC AREAS:** Effective for all climates conditions
- WHAT DEPENDS ON EFFECTIVENESS:**
- Effectiveness for centralised (1) or decentralised (2) depends mainly on the efficiency of the heat recovery system used in each case
  - Effectiveness for (1) and (2) could be improved, assuring optimal air quality conditions all the time, through controlling the ventilation flow and adjusting it according to the air quality (CO<sub>2</sub> level) of each room, or each apartment.

**INTERDEPENDENCIES**

- TYPE OF BUILDINGS** Decentral ventilation is especially used in residential buildings. Heat recovery and mechanical ventilation are used in all kind of buildings

**COMPLEMENTARY & INTERESTING COMBINATIONS**

- The use of autonomous ventilation equipment (1) that connects each space to be ventilated directly to the façade, such as the MovAir SmartFan system solution, with high recovery performance and low electricity consumption (no duct length), can be improved with a drive system depending on the CO<sub>2</sub> level in the environment at any given time, guaranteeing healthy conditions with a minimum energy cost.
- You can use same scaffolders and infrastructure to implement autonomus sets (1) while renovating façades whith ETICs solutions, windows renovation,... Global cost-efficiency will be improved.
- In centralised (1) ventilation systems, the use of Building Automation Systems (BAS) that allow the monitoring of the CO<sub>2</sub> levels of the main spaces, their average, and the regulation of the ventilation flow at all times, can lead to significant savings when occupancy levels are low or intermittent, ensuring healthy conditions with a minimum energy cost.
- With more complex ventilation systems, cost effectiveness could be improved through Building Energy Management Systems(BEMS) and/or other FM operating tools (CAFM, IWMS, BMS,...) which can help with the optimal use of these strategies.

**OBSTACLES / BARRIERS - ADVANTAGES**

- The use of autonomous ventilation equipment (1) that connects each space to be ventilated directly to the façade, such as the MovAir SmartFan system solution, impacts directly in the image of the buildings. So a good architectural integration has to be conceived. Acoustic impacts (in noisy areas) must be analysed.
- Decentralised ventilation systems (1) with one recovery unit per apartment, has less economical impact than autonomus sets (much less sets and less consume), as well as less acoustic and visual impact, but have higher cost in terms of internal space because of volume of needed ducts.
- Centralised ventilation systems (2) require less space losses and electricity consume than (1), but it has more internal noises, smells, and more difficult internal regulation.

**SUCCESS FACTORS**

- A successful key driver to improve energy savings in ventilation systems is to incorporate heat recovery units in the installation, the more efficient in heat recovery set, the more cost-effective.
- Incorporating CO<sub>2</sub> monitoring systems to the main spaces, and regulating the ventilation flow according to the real need to maintain a healthy space, reduces the need for ventilation in spaces little or intermittently occupied, and with a heat recovery system, minimizes the associated energy cost maximizing cost-effectiveness.

## CATEGORY

**WINDOWS STRATEGIES**

## TECHNICAL SOLUTION

**Shading systems**

### COST-EFFECTIVENESS APPROACH

**TYPE OF STRATEGY:** Passive strategy oriented to save energy controlling windows energy gains

**COST-ESTIMATION:** **IMPLEMENTATION:** Medium cost. Higher or lower according to the type of barrier or device used, and needed cost to implement them.

**MAINTENANCE:** Low maintenance costs.

**OPERATION-CONSUMPTIONS:** None in the case of passive or active manually operated barriers, and low in the case of motorised devices.

**EFFECTIVENESS:** **SAVINGS:** Very effective solution, for all kind of buildings.

**EFFICIENCY IMPROVEMENT:**

**ENERGY GENERATION:**

**CLIMATIC AREAS:** Effective for Mediterranean and warm continental climates (south Europe)

**WHAT DEPENDS ON EFFECTIVENESS:**

- Ideal shading system has to control the solar radiation gains through glazing areas, but not prevent daylight, outside view, and natural ventilation.
- Shading systems are much more effective the more external they are, the more passive they are, and the more they do not require user intervention.
- The effectiveness of the systems has to take into account the orientation of the facades and the solar height at each time of year (according to its latitude), so that it protects us from solar radiation in hot summer months, and allows maximum solar gains in winter.

### INTERDEPENDENCIES

**TYPE OF BUILDINGS** All kind of building with existing windows: residential, hospitals, hotels, offices, schools,...

### COMPLEMENTARY & INTERESTING COMBINATIONS

- In warm climates and sun exposed orientations, good shading strategies and low emissivity glazing could be more cost effective than other high performance windows.
- In Mediterranean and warm climates with sun exposed orientations, Shading Strategies is a "must" strategy, and it can improve cost effectiveness of the building retrofitting.
- Shading Strategies in warm climates are complementary of all envelope retrofitting strategies
- Solar Photovoltaics - BIPV : Incorporation of PV panels into shading barriers or devices could improve its cost effectiveness, generating energy as well as providing shading and saving energy.
- Solar Thermal Integration : Similar synergies could be obtained from ST panels
- In general, façade shading is a good option in warm climates, so ventilated façade solutions (combined with ETICS systems) are good options, especially in those orientations most exposed to solar radiation such as west or south.
- The use of external roller shutters, blinds, or louvers depends of users action. One interesting synergy could come from Building automation systems (BAS) (or home automation system), that could open or shut according with energy criteria, improving its cost-effectiveness

### OBSTACLES / BARRIERS - ADVANTAGES

- Implementation of shading barriers or shading devices impacts directly in the image of the buildings. So a good architectural integration has to be conceived.
- Implementation of shading barriers or shading devices can need scaffolders and cranes if are emplaced outdoors
- Internal Shading systems are much more cheaper and easier to install, but is also lesser efficient and depends on users awareness and
- Shading systems can be a great advantage in summer by reducing the need for cooling and improving comfort levels, but they can also have serious disadvantages in winter, generating a greater demand for energy. Either we go to flexible systems that allow optimal performance in summer and winter, or we have to analyse the suitability of the proposals in terms of cost-effectiveness

### SUCCESS FACTORS

- The key success factor is the correct selection of shading barriers or shading devices according to climate conditions, orientations, and latitudes
- For external devices as roller shutters, blinds, or louvers Home automation system can improve its cost-effectiveness through opening or shutting them according with energy criteria.
- The robustness of the systems and the durability of their materials are important to ensure proper user satisfaction.